

SPDT RF Switch

JSW2-63DR+

50Ω 5 to 6000 MHz High Power 3W

The Big Deal

- Single Positive Supply Voltage
- High Power P0.1dB, 3W
- Low Insertion Loss, 0.33 dB at 1 GHz

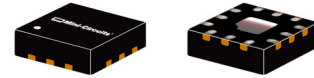

CASE STYLE: MT1818

Product Overview

JSW2-63DR+ is a high-power reflective SPDT RF switch, with reflective short on output ports in the OFF state. Made using a Silicon-on-Insulator process, it provides very high IP3 (55 dBm typ.). This switch also has a built-in CMOS driver and negative voltage generator, all packaged in a tiny 2x2mm package, enabling it to operate over wideband and fit into tight spaces.

Key Features

Feature	Advantages
Wideband operation 5-6000 MHz	Enables a single component to be used in a vast array of applications from VHF up to 6 GHz.
High IIP3: 55 dBm typ.	Results in little or negligible inter-modulation generation, meeting requirements for digital communication signals.
Low Loss, 0.33 dB at 1 GHz & high input power, 3W	Low loss and high power capability enables a single switch to be used for a variety of applications, saving inventory.
Built in negative voltage generator	Operates with single positive supply voltage; no need for DC blocking capacitors, unless external DC is present at the RF ports.
Built-in CMOS driver	No need for external driver, saving PCB space and cost.
Tiny MCLP package 2 x 2mm, 12-lead	Provides low inductance, repeatable transitions, and excellent thermal contact to PCB.



SPDT RF Switch

50Ω 5-6000 MHz

Reflective RF Switch with internal driver.

Single Supply Voltage, +2.3V to +4.8V, High Power 3W

Product Features

- High Isolation, 40 dB typ. at 1 GHz
- Low insertion loss, 0.33 dB typ. at 1 GHz
- High IP3, 55 dBm typ. at 1 GHz
- Low current consumption, 37 μA typ.
- High Power, P0.1dB 3W typ.

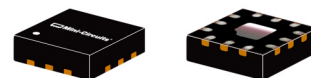

JSW2-63DR+

CASE STYLE: MT1818

Typical Applications

- CATV systems
- SATCOM system
- Automated Test Stations

+RoHS Compliant
The +Suffix identifies RoHS Compliance. See our web site for RoHS Compliance methodologies and qualifications

General Description

JSW2-63DR+ is a high power 3W reflective SPDT switch with integral CMOS driver, operates with single positive supply voltage while consuming, 37μA typical. JSW is a reflective short on output port in OFF state. It has been designed for very wideband operation of 5-6000 MHz. It is packaged in a tiny 2mm x 2mm x 0.55mm package and is rated MSL1 and class 1B for ESD (HBM)

Simplified Schematic and Pad Description

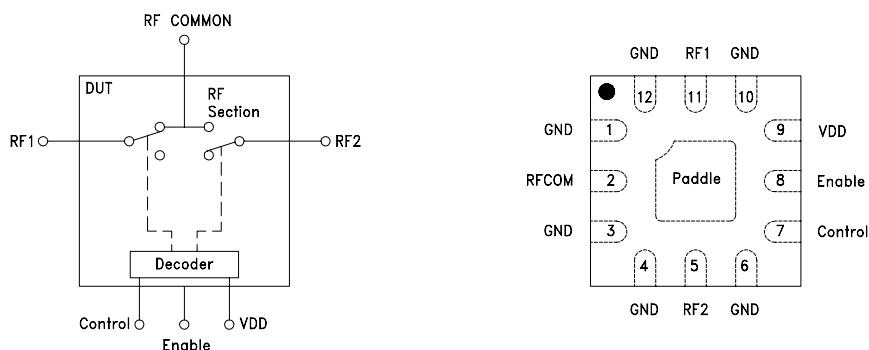

Function	Pad Number	Description
RF COM	2	RF Common/ SUM Port, (see Fig. 2)
RF1	11	RF Out #1/In Port #1, (see Fig. 2)
RF2	5	RF Out #1/In Port #2, (see Fig. 2)
Control	7	CMOS Control IN
VDD	9	Supply Voltage
Enable	8	Shutdown mode enabled by connecting to logic low
GND	1,3,4,6,10,12	Ground

RF Electrical Specifications⁽¹⁾, 5 - 6000 MHz, T_{AMB}=25°C, V_{DD}= +2.3 to 4.8V

Parameter	Condition (MHz)	Min.	Typ.	Max.	Units
Frequency Range		5		6000	MHz
Insertion Loss ⁽²⁾ (ON STATE)	5 to 1000		0.33	0.40	dB
	1000 to 2500		0.40	0.50	
	2500 to 5000		0.57	0.75	
	5000 to 6000		0.57	0.80	
Isolation between Common port and RF1/RF2 Ports	5 to 1000	40	42		dB
	1000 to 2500	30	33		
	2500 to 5000	22	24		
	5000 to 6000	18	21		
Isolation between RF1 and RF2 ports ⁽³⁾	5 to 1000	40	46		dB
	1000 to 2500	30	35		
	2500 to 5000	22	26		
	5000 to 6000	18	22		
Return Loss (ON STATE), all ports	5 to 1000		25		dB
	1000 to 2500		22		
	2500 to 5000		14		
	5000 to 6000		14		
Input IP3 (V _{DD} =3V)	5 to 1000		56		dBm
	1000 to 2500		62		
	2500 to 5000		59		
	5000 to 6000		59		
0.1dB Input Compression ⁽⁴⁾	5 to 6000		35		dBm

DC Operating Electrical Specifications

Parameter	Min.	Typ.	Max.	Units
VDD, Supply Voltage	2.3		4.8	V
Supply Current		37		μA
Control Enable Voltage Low	0		0.4	V
Control Enable Voltage High	1.65		VDD	V
Control Current		1		μA
Shutdown mode - Supply Current		7		μA

Notes:

1. Tested on Mini-Circuit's test board TB-725+ (see Characterization Test Circuit, Fig.1).
2. Insertion loss values are de-embedded from test board loss.
3. Enable voltage "HI", either RF1 or RF2 are ON.
4. Do not exceed RF input power as shown in Absolute Maximum Rating table.

Switching Specifications

Parameter	Min.	Typ.	Max.	Units
Rise/Fall Time (10 to 90% or 90 to 10% RF)	—	0.5 (Rise Time) 0.7 (Fall Time)	—	μSec
Switching Time, 50% CTRL to 90/10% RF	—	1.9 (ON Time) 1.1 (OFF Time)	—	μSec
Video Feedthrough, (control 0 to 1.65V, freq.=10 KHz)	—	3.0	—	mV _{p,p}

Absolute Maximum Ratings⁽⁵⁾

Parameter	Ratings
Operating Temperature	-40°C to +85°C
Storage Temperature	-55°C to 125°C
V _{DD} , Supply Voltage	5.0V
Voltage Control	-0.2V Min. V _{DD} Max.
RF input power	5 Watt ⁶

5. Operation of this device above any of these conditions may cause permanent damage.

6. Derate linearly to 2.5W at 85°C.

Truth Table (State of control and enable voltage selects the desired switch state)

State of:		RF Common to	
Control Voltage	Enable Voltage	RF1	RF2
High	High	ON	OFF
Low	High	OFF	ON
Low/High	Low	Shutdown	

ON- low insertion loss state OFF- Isolation State

Characterization Test Circuit

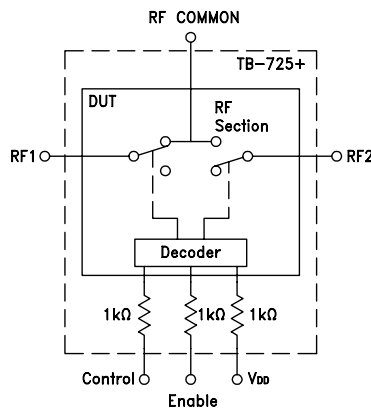

Figure 1: Block Diagram Of Test Circuit Used For Characterization. (DUT soldered on Mini-Circuit's TB-725+)

Test Equipment:

For Insertion loss, Isolation, Return loss:

Agilent's N5230A Network Analyzer , E3631A power supply.

For Switching Time and Video Feed through

Agilent's AG54832B HP81110A pulse generator, HPE3631A Network Analyzer , E3631A power supply.

Agilent's N90A Spectrum Analyzer , E8257D Generator U200A

For Compression:

R&S Network Analyzer ZVA24, E3631A power supply.

Conditions:

V_{DD}= +2.3 and +4.8V, Control= 0 and 1.65V.

For Insertion loss, isolation and return loss: Pin=0 dBm

For Input IP3: Pin=+10dBm/tone.

For Switching time: RF frequency: 500 MHz at 0 dBm, Control Frequency: 10 KHz and 0 and +1.65V.

Product Marking

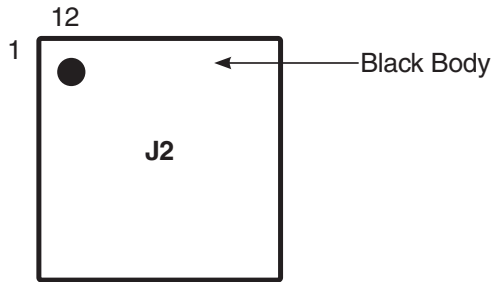

Recommended Application Circuit

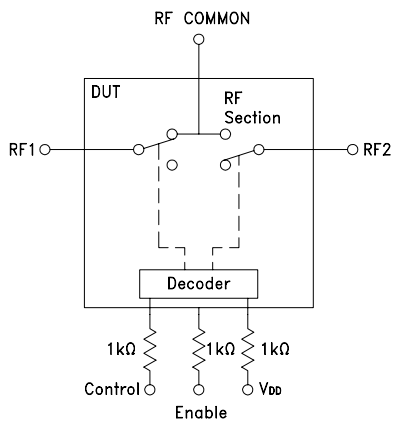

Fig. 2: Evaluation board includes case, connectors and components soldered to PCB.

Additional Detailed Technical Information	
<i>additional information is available on our dash board. To access this information click here</i>	
Performance Data	Data Table
	Swept Graphs
Case Style	MT1818 <i>Plastic package; Lead finish: NiPd Au</i>
Tape & Reel	F108
Standard quantities available on reel	<i>7" reels with 20, 50, 100, 200, 500, 1K or 3K devices</i>
Suggested Layout for PCB Design	PL-414
Evaluation Board	TB-725+
Environmental Ratings	ENV75

ESD Rating

Human Body Model (HBM): Class 1B (500 to < 1000V) in accordance with JESD22-A114

Machine Model (MM): Class A (Pass 100V) in accordance with JESD22-A115

MSL Rating

Moisture Sensitivity: MSL1 in accordance with IPC/JEDEC J-STD-020D

MSL Test Flow Chart

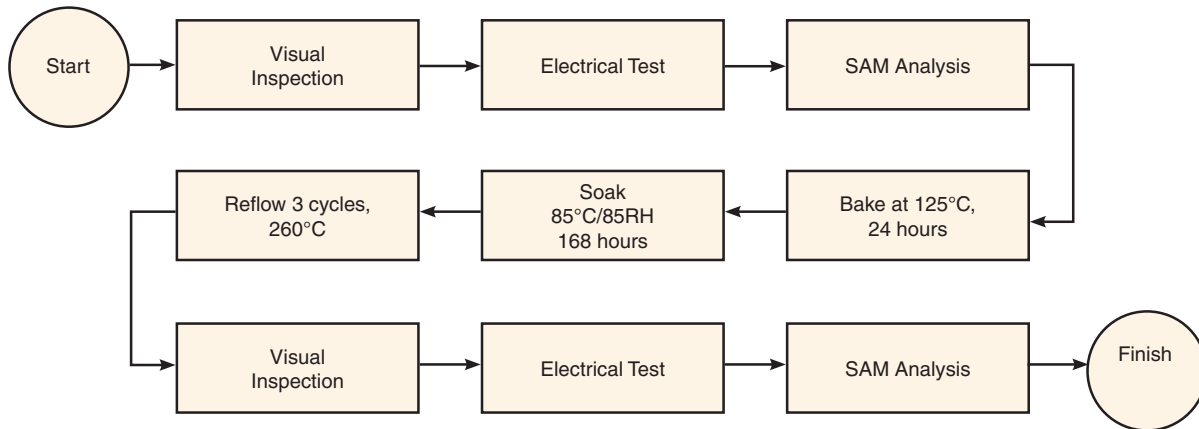

Additional Notes

- A. Performance and quality attributes and conditions not expressly stated in this specification document are intended to be excluded and do not form a part of this specification document.
- B. Electrical specifications and performance data contained in this specification document are based on Mini-Circuit's applicable established test performance criteria and measurement instructions.
- C. The parts covered by this specification document are subject to Mini-Circuits standard limited warranty and terms and conditions (collectively, "Standard Terms"); Purchasers of this part are entitled to the rights and benefits contained therein. For a full statement of the Standard Terms and the exclusive rights and remedies thereunder, please visit Mini-Circuits' website at www.minicircuits.com/MCLStore/terms.jsp

Typical Performance Data

RF FREQ (MHz)	INSERTION LOSS (dB)						RF FREQ (MHz)	ISOLATION (dB) (ENABLE-HIGH*)											
	VDD=+2.3V		VDD=+3V		VDD=+4.8V			VDD=+2.3V		VDD=+3V		VDD=+4.8V		VDD=+2.3V		VDD=+3V		VDD=+4.8V	
	RF COM-RF1	RF COM-RF2	RF COM-RF1	RF COM-RF2	RF COM-RF1	RF COM-RF2		RF COM-RF1	RF COM-RF2	RF COM-RF1	RF COM-RF2	RF COM-RF1	RF COM-RF2	RF1-RF2 Control LOW*	RF1-RF2 Control HIGH*	RF1-RF2 Control LOW*	RF1-RF2 Control HIGH*	RF1-RF2 Control LOW*	RF1-RF2 Control HIGH*
10.0	0.28	0.27	0.28	0.27	0.28	0.27	10.0	67.16	69.44	77.93	68.68	72.45	80.82	75.45	80.45	77.62	76.04	94.78	82.09
50.0	0.28	0.28	0.28	0.27	0.28	0.27	50.0	67.11	70.00	66.24	70.76	68.51	68.25	71.37	70.02	71.30	70.60	70.20	70.43
100.0	0.28	0.28	0.28	0.28	0.28	0.28	100.0	62.79	62.80	62.73	63.09	62.86	62.90	66.92	67.06	67.38	67.00	67.09	67.10
200.0	0.29	0.28	0.29	0.28	0.29	0.28	200.0	56.79	56.64	56.83	56.71	56.79	56.74	61.31	60.93	61.40	61.13	61.29	61.06
300.0	0.29	0.29	0.29	0.29	0.29	0.29	300.0	53.09	53.10	53.23	53.16	53.19	53.08	57.77	57.40	57.69	57.57	57.65	57.38
400.0	0.30	0.29	0.29	0.29	0.29	0.29	400.0	50.60	50.58	50.60	50.59	50.63	50.56	55.11	54.81	55.26	54.99	55.26	54.88
500.0	0.30	0.30	0.30	0.29	0.30	0.29	500.0	48.63	48.56	48.62	48.66	48.68	48.59	53.18	52.82	53.30	52.78	53.37	52.76
600.0	0.30	0.30	0.30	0.30	0.30	0.30	600.0	46.99	47.01	47.10	47.04	47.06	47.02	51.49	51.04	51.62	51.18	51.56	51.16
700.0	0.31	0.31	0.31	0.31	0.31	0.31	700.0	45.62	45.61	45.67	45.70	45.66	45.69	50.16	49.60	50.22	49.72	50.21	49.66
800.0	0.31	0.31	0.31	0.31	0.31	0.31	800.0	44.39	44.48	44.48	44.50	44.45	44.48	48.84	48.35	48.98	48.40	48.90	48.39
900.0	0.31	0.31	0.31	0.31	0.31	0.31	900.0	43.32	43.41	43.38	43.46	43.38	43.45	47.70	47.12	47.80	47.25	47.74	47.20
1000.0	0.32	0.32	0.31	0.31	0.32	0.31	1000.0	42.35	42.45	42.42	42.51	42.40	42.48	46.67	46.09	46.76	46.18	46.72	46.19
1200.0	0.32	0.32	0.32	0.32	0.32	0.32	1200.0	40.62	40.78	40.72	40.84	40.69	40.84	44.89	44.24	44.95	44.31	44.96	44.30
1400.0	0.33	0.33	0.33	0.33	0.33	0.33	1400.0	39.16	39.36	39.21	39.41	39.21	39.41	43.28	42.62	43.38	42.64	43.32	42.61
1600.0	0.34	0.34	0.34	0.34	0.34	0.34	1600.0	37.82	38.10	37.87	38.14	37.87	38.13	41.86	40.99	41.98	41.15	41.93	41.16
1800.0	0.34	0.35	0.34	0.34	0.34	0.35	1800.0	36.65	36.99	36.68	37.01	36.68	36.99	40.59	39.77	40.72	39.75	40.66	39.81
2000.0	0.35	0.36	0.35	0.36	0.35	0.36	2000.0	35.56	35.95	35.63	35.98	35.61	35.97	39.46	38.54	39.54	38.65	39.48	38.53
2200.0	0.36	0.37	0.36	0.36	0.36	0.37	2200.0	34.55	35.00	34.64	35.03	34.60	35.02	38.42	37.37	38.51	37.49	38.45	37.41
2400.0	0.37	0.37	0.37	0.37	0.37	0.37	2400.0	33.63	34.15	33.68	34.17	33.63	34.16	37.44	36.35	37.52	36.39	37.47	36.33
2600.0	0.37	0.38	0.37	0.38	0.37	0.38	2600.0	32.72	33.33	32.73	33.36	32.71	33.34	36.54	35.37	36.59	35.33	36.57	35.29
2800.0	0.37	0.38	0.37	0.38	0.37	0.38	2800.0	31.84	32.55	31.87	32.59	31.87	32.59	35.71	34.46	35.77	34.36	35.75	34.40
3000.0	0.37	0.38	0.37	0.39	0.37	0.38	3000.0	31.01	31.84	30.94	31.86	31.03	31.85	34.87	33.50	34.92	33.37	34.90	33.45
3200.0	0.38	0.39	0.38	0.39	0.38	0.39	3200.0	30.35	31.13	30.15	31.16	30.29	31.15	34.13	32.83	34.14	32.73	34.16	32.72
3400.0	0.38	0.39	0.38	0.39	0.38	0.39	3400.0	29.58	30.49	29.68	30.53	29.48	30.51	33.37	31.96	33.39	32.30	33.38	31.91
3600.0	0.39	0.41	0.39	0.40	0.40	0.41	3600.0	28.94	29.90	29.15	29.92	28.74	29.88	32.66	31.17	32.68	31.47	32.65	31.18
3800.0	0.41	0.42	0.41	0.42	0.41	0.43	3800.0	28.25	29.31	28.44	29.33	28.24	29.31	32.00	30.55	32.03	30.57	32.00	30.61
4000.0	0.44	0.45	0.43	0.44	0.44	0.45	4000.0	27.54	28.72	27.62	28.77	27.68	28.72	31.26	29.76	31.32	29.68	31.23	29.97
4200.0	0.47	0.49	0.47	0.49	0.47	0.48	4200.0	26.70	28.13	26.75	28.19	27.13	28.19	30.60	29.01	30.69	28.84	30.65	29.36
4400.0	0.49	0.51	0.49	0.51	0.48	0.49	4400.0	26.28	27.57	26.04	27.57	26.62	27.61	29.95	28.50	29.92	28.41	29.89	28.70
4600.0	0.52	0.54	0.52	0.54	0.52	0.53	4600.0	25.84	27.01	25.97	27.05	25.98	27.05	29.26	28.04	29.24	28.21	29.23	27.97
4800.0	0.53	0.55	0.53	0.55	0.52	0.54	4800.0	25.30	26.47	25.46	26.50	25.27	26.52	28.55	27.55	28.61	27.40	28.61	27.16
5000.0	0.54	0.56	0.54	0.56	0.54	0.55	5000.0	24.76	25.93	24.72	25.93	24.67	25.95	27.83	26.45	27.89	26.52	27.89	26.43
5200.0	0.53	0.56	0.53	0.56	0.53	0.56	5200.0	24.03	25.33	24.01	25.36	23.80	25.38	27.17	25.83	27.21	25.72	27.30	25.47
5400.0	0.51	0.55	0.52	0.55	0.52	0.55	5400.0	23.41	24.75	23.29	24.80	23.10	24.81	26.43	25.04	26.51	24.86	26.60	24.67
5600.0	0.50	0.54	0.50	0.54	0.50	0.55	5600.0	22.68	24.22	22.55	24.22	22.48	24.21	25.90	24.19	25.90	24.10	25.97	24.05
5800.0	0.48	0.52	0.48	0.52	0.48	0.53	5800.0	21.96	23.61	22.10	23.58	22.02	23.54	25.16	23.38	25.15	23.56	25.22	23.57
6000.0	0.46	0.52	0.46	0.51	0.47	0.53	6000.0	21.46	23.01	21.54	23.01	21.42	22.95	24.51	22.60	24.51	22.90	24.55	22.96
6200.0	0.45	0.53	0.44	0.52	0.45	0.52	6200.0	20.84	22.52	20.89	22.51	20.94	22.42	23.99	21.60	23.96	22.16	23.91	22.39
6400.0	0.46	0.57	0.45	0.54	0.44	0.52	6400.0	19.92	21.90	20.22	21.99	20.42	21.88	23.28	21.39	23.38	21.36	23.24	21.72
6600.0	0.48	0.59	0.46	0.59	0.45	0.54	6600.0	19.87	21.22	19.55	21.40	19.98	21.37	22.59	21.27	22.81	20.76	22.64	21.22
6800.0	0.48	0.61	0.50	0.64	0.47	0.58	6800.0	19.43	20.73	19.24	20.85	19.47	20.92	22.00	20.71	22.17	20.44	22.06	20.54
7000.0	0.50	0.60	0.53	0.65	0.50	0.62	7000.0	19.26	20.38	19.04	20.34	19.01	20.46	21.40	20.41	21.48	20.21	21.52	20.09
7200.0	0.54	0.64	0.54	0.65	0.54	0.67	7200.0	18.87	20.01	18.92	19.95	18.62	20.12	21.04	20.16	20.99	20.04	21.14	19.65
7400.0	0.56	0.65	0.57	0.67	0.59	0.72	7400.0	18.58	19.70	18.59	19.59	18.34	19.66	20.57	19.53	20.44	19.54	20.61	19.23
7600.0	0.59	0.72	0.60	0.71	0.62	0.75	7600.0	17.95	19.39	18.19	19.27	17.98	19.26	20.26	19.07	20.16	19.19	20.27	18.91
7800.0	0.64	0.78	0.64	0.75	0.66	0.79	7800.0	17.66	19.06	17.79	18.99	17.74	18.92	19.90	18.26	19.77	18.65	19.77	18.55
8000.0	0.66	0.81	0.66	0.77	0.68	0.80	8000.0	17.42	18.59	17.45	18.61	17.51	18.45	19.64	17.97	19.37	18.24	19.36	18.24

*Note:

State of:		RF Common to	
Control Voltage	Enable	RF1	RF2
HIGH	HIGH	ON	OFF
LOW	HIGH	OFF	ON
LOW/HIGH	LOW	Shutdown	

ON - Low insertion loss state
 OFF - Isolation state



P.O. Box 350166, Brooklyn, New York 11235-0003 (718) 934-4500 • Fax (718) 332-4661 For detailed performance specs & shopping online see Mini-Circuits web site
 The Design Engineers Search Engine Provides ACTUAL Data Instantly From MINI-CIRCUITS At: www.minicircuits.com

IF/RF MICROWAVE COMPONENTS

Typical Performance Data

RF FREQ (MHz)	VSWR (:1)-ON STATE (ENABLE-HIGH*)												RF FREQ (MHz)	VSWR (:1)- OFF STATE (ENABLE-HIGH*)						
	VDD=+2.3V				VDD=+3V				VDD=+4.8V					VDD=+2.3V		VDD=+3V		VDD=+4.8V		
	RF COM		RF1	RF2	RF COM		RF1	RF2	RF COM		RF1	RF2		RF1	RF2	RF1	RF2			
	Control LOW*	Control HIGH*	Control HIGH*	Control LOW*	Control LOW*	Control HIGH*	Control HIGH*	Control LOW*	Control LOW*	Control HIGH*	Control HIGH*	Control LOW*		Control HIGH*	Control HIGH*	Control LOW*	Control HIGH*			
10.0	1.04	1.04	1.05	1.04	1.04	1.04	1.04	1.04	1.05	1.04	1.05	1.05	1.05	3.76	3.79	3.80	3.82	3.79	3.81	
50.0	1.04	1.04	1.04	1.04	1.04	1.04	1.04	1.04	1.04	1.04	1.04	1.04	1.04	3.76	3.79	3.79	3.82	3.77	3.81	
100.0	1.04	1.04	1.04	1.04	1.04	1.04	1.04	1.04	1.04	1.04	1.04	1.04	1.04	3.75	3.78	3.79	3.82	3.76	3.80	
200.0	1.05	1.05	1.04	1.04	1.05	1.05	1.04	1.04	1.05	1.05	1.04	1.04	1.04	3.73	3.76	3.76	3.80	3.75	3.78	
300.0	1.05	1.05	1.05	1.04	1.05	1.05	1.05	1.04	1.05	1.05	1.05	1.05	1.05	3.72	3.76	3.76	3.79	3.73	3.78	
400.0	1.05	1.05	1.05	1.05	1.05	1.05	1.05	1.05	1.05	1.05	1.05	1.05	1.05	3.70	3.75	3.73	3.78	3.72	3.76	
500.0	1.06	1.06	1.06	1.05	1.06	1.06	1.06	1.05	1.06	1.06	1.06	1.05	1.05	3.68	3.73	3.72	3.76	3.70	3.74	
600.0	1.06	1.06	1.06	1.06	1.06	1.06	1.06	1.06	1.06	1.06	1.06	1.06	1.06	3.67	3.71	3.70	3.75	3.68	3.73	
700.0	1.07	1.07	1.07	1.07	1.07	1.07	1.07	1.07	1.07	1.07	1.07	1.07	1.07	3.65	3.69	3.69	3.73	3.67	3.70	
800.0	1.08	1.07	1.08	1.07	1.08	1.07	1.08	1.07	1.07	1.07	1.08	1.07	1.07	3.62	3.67	3.66	3.71	3.65	3.69	
900.0	1.08	1.08	1.09	1.08	1.08	1.08	1.09	1.08	1.07	1.08	1.09	1.08	1.08	3.60	3.66	3.64	3.70	3.62	3.68	
1000.0	1.09	1.09	1.10	1.09	1.09	1.09	1.10	1.09	1.08	1.08	1.10	1.09	1.09	3.58	3.65	3.62	3.67	3.60	3.66	
1200.0	1.10	1.10	1.11	1.10	1.10	1.09	1.11	1.10	1.09	1.09	1.10	1.09	1.09	3.56	3.61	3.59	3.65	3.58	3.64	
1400.0	1.11	1.11	1.13	1.12	1.11	1.11	1.13	1.12	1.11	1.11	1.13	1.12	1.12	3.50	3.57	3.54	3.60	3.53	3.59	
1600.0	1.12	1.12	1.14	1.13	1.12	1.12	1.14	1.13	1.12	1.12	1.14	1.13	1.13	3.46	3.53	3.48	3.56	3.49	3.55	
1800.0	1.13	1.13	1.15	1.14	1.13	1.13	1.15	1.14	1.13	1.13	1.15	1.14	1.14	3.41	3.48	3.44	3.51	3.44	3.50	
2000.0	1.14	1.15	1.16	1.16	1.14	1.15	1.16	1.16	1.15	1.15	1.17	1.16	1.16	3.36	3.43	3.39	3.46	3.40	3.45	
2200.0	1.15	1.15	1.17	1.16	1.15	1.15	1.17	1.16	1.15	1.15	1.17	1.16	1.16	3.31	3.37	3.34	3.40	3.34	3.39	
2400.0	1.15	1.15	1.16	1.16	1.15	1.16	1.16	1.15	1.15	1.16	1.17	1.16	1.16	3.26	3.33	3.29	3.35	3.27	3.35	
2600.0	1.13	1.14	1.14	1.14	1.13	1.14	1.15	1.14	1.13	1.15	1.15	1.14	1.14	3.22	3.30	3.26	3.33	3.25	3.31	
2800.0	1.10	1.12	1.11	1.11	1.10	1.12	1.11	1.11	1.11	1.13	1.12	1.11	1.11	3.20	3.27	3.24	3.30	3.21	3.29	
3000.0	1.07	1.10	1.09	1.08	1.08	1.10	1.09	1.08	1.08	1.11	1.09	1.09	1.09	3.21	3.26	3.24	3.29	3.24	3.27	
3200.0	1.06	1.08	1.06	1.04	1.06	1.08	1.05	1.04	1.06	1.08	1.05	1.04	1.04	3.24	3.27	3.25	3.30	3.25	3.29	
3400.0	1.07	1.08	1.07	1.04	1.07	1.08	1.07	1.04	1.07	1.07	1.07	1.04	1.04	3.30	3.30	3.31	3.33	3.29	3.32	
3600.0	1.12	1.11	1.12	1.09	1.13	1.12	1.12	1.09	1.13	1.12	1.12	1.09	1.09	3.38	3.39	3.43	3.42	3.39	3.40	
3800.0	1.18	1.17	1.18	1.15	1.19	1.17	1.18	1.15	1.19	1.17	1.18	1.15	1.15	3.800.0	3.51	3.50	3.56	3.54	3.52	
4000.0	1.25	1.22	1.25	1.21	1.25	1.22	1.25	1.21	1.25	1.22	1.25	1.22	1.22	4000.0	3.68	3.62	3.73	3.65	3.69	3.63
4200.0	1.33	1.30	1.32	1.29	1.33	1.30	1.33	1.29	1.33	1.31	1.33	1.30	1.30	4200.0	3.84	3.79	3.88	3.82	3.86	3.81
4400.0	1.38	1.34	1.38	1.35	1.38	1.34	1.38	1.35	1.37	1.34	1.38	1.35	1.35	4400.0	3.99	3.95	4.01	4.00	4.06	3.98
4600.0	1.44	1.41	1.44	1.41	1.44	1.41	1.44	1.41	1.44	1.41	1.44	1.41	1.41	4600.0	4.22	4.15	4.26	4.20	4.27	4.16
4800.0	1.46	1.43	1.46	1.44	1.46	1.43	1.47	1.44	1.44	1.42	1.45	1.43	1.43	4800.0	4.40	4.33	4.46	4.37	4.41	4.37
5000.0	1.48	1.45	1.49	1.46	1.47	1.44	1.48	1.46	1.47	1.44	1.48	1.45	1.45	5000.0	4.60	4.51	4.64	4.55	4.61	4.52
5200.0	1.46	1.44	1.46	1.44	1.46	1.43	1.46	1.44	1.44	1.41	1.44	1.42	1.42	5200.0	4.69	4.62	4.73	4.66	4.69	4.63
5400.0	1.41	1.38	1.42	1.40	1.41	1.38	1.42	1.40	1.40	1.37	1.41	1.39	1.39	5400.0	4.80	4.74	4.83	4.78	4.78	4.75
5600.0	1.37	1.34	1.38	1.36	1.37	1.34	1.38	1.36	1.37	1.33	1.37	1.36	1.36	5600.0	4.87	4.80	4.88	4.84	4.86	4.83
5800.0	1.30	1.26	1.30	1.27	1.30	1.25	1.30	1.27	1.29	1.25	1.30	1.28	1.28	5800.0	4.88	4.78	4.87	4.80	4.80	4.79
6000.0	1.23	1.18	1.23	1.20	1.23	1.18	1.23	1.21	1.24	1.20	1.25	1.23	1.23	6000.0	4.86	4.72	4.86	4.75	4.79	4.77
6200.0	1.14	1.10	1.14	1.14	1.14	1.11	1.15	1.14	1.16	1.12	1.16	1.16	1.16	6200.0	4.69	4.64	4.74	4.69	4.69	4.70
6400.0	1.08	1.03	1.08	1.07	1.07	1.03	1.07	1.07	1.08	1.04	1.09	1.08	1.08	6400.0	4.55	4.52	4.63	4.56	4.62	4.56
6600.0	1.02	1.03	1.04	1.04	1.01	1.04	1.03	1.04	1.03	1.01	1.03	1.04	1.04	6600.0	4.35	4.39	4.43	4.42	4.45	4.43
6800.0	1.08	1.10	1.09	1.07	1.08	1.11	1.10	1.07	1.08	1.11	1.08	1.08	1.08	6800.0	4.23	4.22	4.26	4.27	4.30	4.26
7000.0	1.16	1.18	1.16	1.14	1.15	1.17	1.17	1.13	1.14	1.17	1.15	1.14	1.14	7000.0	4.09	4.14	4.09	4.18	4.15	4.13
7200.0	1.23	1.24	1.23	1.20	1.23	1.24	1.23	1.20	1.22	1.25	1.23	1.21	1.21	7200.0	3.92	4.01	3.94	4.04	3.97	4.01
7400.0	1.28	1.31	1.28	1.27	1.28	1.30	1.28	1.26	1.28	1.33	1.29	1.27	1.27	7400.0	3.85	3.86	3.86	3.88	3.86	3.84
7600.0	1.31	1.33	1.32	1.29	1.31	1.34	1.32	1.30	1.31	1.34	1.32	1.29	1.29	7600.0	3.74	3.79	3.77	3.81	3.76	3.75
7800.0	1.37	1.40	1.37	1.36	1.37	1.40	1.36	1.35	1.39	1.42	1.38	1.34	1.34	7800.0	3.64	3.65	3.67	3.67	3.64	3.70
8000.0	1.35	1.39	1.36	1.34	1.36	1.39	1.36	1.34	1.36	1.40	1.37	1.34	1.34	8000.0	3.59	3.58	3.64	3.60	3.64	3.59

*Note:

State of:		RF Common to	
Control Voltage	Enable	RF1	RF2
HIGH	HIGH	ON	OFF
LOW	HIGH	OFF	ON
LOW/HIGH	LOW	Shutdown	

ON - Low insertion loss state
OFF - Isolation state



P.O. Box 350166, Brooklyn, New York 11235-0003 (718) 934-4500 • Fax (718) 332-4661 For detailed performance specs & shopping online see Mini-Circuits web site
The Design Engineers Search Engine Provides ACTUAL Data Instantly From MINI-CIRCUITS At: www.minicircuits.com

IF/RF MICROWAVE COMPONENTS

REV. OR
JSW2-63DR+
3/13/2013
Page 2 of 9

RF Switch SPDT

JSW2-63DR+

Typical Performance Data

RF FREQ (MHz)	INPUT IP3 (dBm)		RF FREQ (MHz)	COMPRESSION (dB) @ FIXED POWER FOR PIN=34.5dBm	
	VDD=+3V			VDD=+3V	
	RF COM-RF1	RF COM-RF2		RF COM-RF1	RF COM-RF2
10.0	56.33	56.63	200.0	0.00	0.00
50.0	60.08	59.79	300.0	0.00	0.00
100.0	61.79	61.16	400.0	0.00	0.00
200.0	63.24	63.12	500.0	0.00	0.01
300.0	61.57	60.60	600.0	-0.02	-0.01
400.0	63.08	62.28	700.0	-0.01	-0.01
500.0	67.05	67.90	800.0	-0.02	-0.02
600.0	62.28	62.59	900.0	-0.01	-0.02
700.0	65.27	65.45	1000.0	-0.03	-0.02
800.0	62.01	62.30	1200.0	-0.02	-0.02
900.0	62.65	62.58	1400.0	-0.05	-0.03
1000.0	67.76	66.95	1600.0	-0.05	-0.05
1200.0	62.06	62.89	1800.0	-0.06	-0.06
1400.0	64.26	66.77	2000.0	-0.08	-0.06
1600.0	64.66	63.98	2200.0	-0.08	-0.07
1800.0	65.54	67.66	2400.0	-0.08	-0.07
2000.0	64.02	64.13	2600.0	0.02	0.00
2200.0	63.16	63.48	2800.0	0.02	0.00
2400.0	63.49	65.64	3000.0	0.02	0.02
2600.0	65.25	65.25	3200.0	0.02	0.02
2800.0	65.96	66.00	3400.0	0.01	0.01
3000.0	63.76	63.17	3600.0	0.02	0.02
3200.0	62.33	62.17	3800.0	0.02	0.01
3400.0	62.82	62.56	4000.0	0.01	0.01
3600.0	61.77	61.20	4200.0	0.03	0.00
3800.0	60.23	59.81	4400.0	0.01	0.00
4000.0	60.20	60.33	4600.0	0.00	0.02
4200.0	63.45	63.66	4800.0	0.02	0.01
4400.0	61.66	61.95	5000.0	0.02	0.02
4600.0	60.89	61.12	5200.0	0.00	0.02
4800.0	60.63	60.77	5400.0	0.01	0.01
5000.0	63.41	64.90	5600.0	0.03	0.01
5200.0	60.84	61.79	5800.0	0.01	0.02
5400.0	61.67	61.65	6000.0	0.02	0.02
5600.0	64.74	64.20			
5800.0	62.95	63.54			
6000.0	61.68	62.33			



P.O. Box 350166, Brooklyn, New York 11235-0003 (718) 934-4500 • Fax (718) 332-4661 For detailed performance specs & shopping online see Mini-Circuits web site



The Design Engineers Search Engine Provides ACTUAL Data Instantly From MINI-CIRCUITS At: www.minicircuits.com

IF/RF MICROWAVE COMPONENTS

REV. OR
JSW2-63DR+
3/13/2013
Page 3 of 9

Typical Performance Data

RF FREQ (MHz)	INSERTION LOSS (dB) @ VDD=+3V OVER TEMPERATURE (ENABLE-HIGH*)						RF FREQ (MHz)	ISOLATION (dB) @ VDD=+3V OVER TEMPERATURE (ENABLE-HIGH*)											
	RF COM-RF1			RF COM-RF2				RF COM-RF1			RF COM-RF2			RF1-RF2 Control LOW*			RF1-RF2 Control HIGH*		
	-45°C	+25°C	+85°C	-45°C	+25°C	+85°C		-45°C	+25°C	+85°C	-45°C	+25°C	+85°C	-45°C	+25°C	+85°C	-45°C	+25°C	+85°C
10.0	0.23	0.28	0.33	0.22	0.27	0.32	10.0	77.00	77.93	68.34	71.18	68.68	67.87	80.62	77.62	79.90	75.47	76.04	76.35
50.0	0.23	0.28	0.32	0.22	0.27	0.32	50.0	68.09	66.24	65.48	73.40	70.76	68.97	77.66	71.30	69.57	73.47	70.60	70.46
100.0	0.23	0.28	0.33	0.23	0.28	0.32	100.0	64.59	62.73	61.62	64.57	63.09	61.74	71.12	67.38	65.62	70.49	67.00	64.94
200.0	0.23	0.29	0.33	0.22	0.28	0.33	200.0	58.27	56.83	55.67	58.10	56.71	55.59	64.49	61.40	59.52	63.85	61.13	59.22
300.0	0.22	0.29	0.34	0.22	0.29	0.34	300.0	54.52	53.23	52.19	54.53	53.16	52.12	60.56	57.69	56.09	60.07	57.57	55.64
400.0	0.22	0.29	0.35	0.21	0.29	0.35	400.0	51.93	50.60	49.58	51.97	50.59	49.56	57.93	55.26	53.46	57.48	54.99	53.22
500.0	0.21	0.30	0.36	0.21	0.29	0.36	500.0	50.01	48.62	47.62	49.94	48.66	47.64	55.91	53.30	51.47	55.26	52.78	51.15
600.0	0.21	0.30	0.37	0.20	0.30	0.37	600.0	48.37	47.10	46.01	48.38	47.04	46.05	54.04	51.62	49.88	53.41	51.18	49.58
700.0	0.21	0.31	0.38	0.20	0.31	0.38	700.0	46.95	45.67	44.71	46.99	45.70	44.69	52.64	50.22	48.54	51.86	49.72	48.19
800.0	0.20	0.31	0.39	0.19	0.31	0.39	800.0	45.75	44.48	43.49	45.79	44.50	43.52	51.27	48.98	47.36	50.53	48.40	46.90
900.0	0.20	0.31	0.40	0.19	0.31	0.40	900.0	44.61	43.38	42.43	44.72	43.46	42.49	49.98	47.80	46.22	49.18	47.25	45.77
1000.0	0.20	0.31	0.40	0.19	0.31	0.41	1000.0	43.62	42.42	41.51	43.70	42.51	41.55	48.81	46.76	45.24	48.03	46.18	44.80
1200.0	0.19	0.32	0.42	0.18	0.32	0.42	1200.0	41.79	40.72	39.82	41.99	40.84	39.92	46.83	44.95	43.52	45.94	44.31	43.01
1400.0	0.19	0.33	0.43	0.18	0.33	0.44	1400.0	40.27	39.21	38.38	40.51	39.41	38.54	45.09	43.38	42.03	44.15	42.64	41.47
1600.0	0.19	0.34	0.45	0.17	0.34	0.45	1600.0	38.84	37.87	37.11	39.20	38.14	37.32	43.50	41.98	40.73	42.42	41.15	40.11
1800.0	0.18	0.34	0.46	0.17	0.34	0.47	1800.0	37.61	36.68	35.98	37.99	37.01	36.25	42.07	40.72	39.53	40.93	39.75	38.84
2000.0	0.19	0.35	0.47	0.18	0.36	0.49	2000.0	36.40	35.63	34.94	36.89	35.98	35.24	40.77	39.54	38.45	39.55	38.65	37.70
2200.0	0.18	0.36	0.49	0.17	0.36	0.50	2200.0	35.33	34.64	33.99	35.86	35.03	34.34	39.59	38.51	37.50	38.26	37.49	36.64
2400.0	0.18	0.37	0.50	0.17	0.37	0.51	2400.0	34.30	33.68	33.08	34.91	34.17	33.53	38.47	37.52	36.59	37.10	36.39	35.68
2600.0	0.17	0.37	0.51	0.16	0.38	0.53	2600.0	33.31	32.73	32.25	34.06	33.36	32.73	37.43	36.59	35.76	35.98	35.33	34.77
2800.0	0.16	0.37	0.52	0.16	0.38	0.54	2800.0	32.37	31.87	31.42	33.19	32.59	32.02	36.48	35.77	35.02	34.99	34.36	33.96
3000.0	0.16	0.37	0.53	0.15	0.39	0.55	3000.0	31.44	30.94	30.62	32.43	31.86	31.32	35.50	34.92	34.23	33.81	33.37	33.04
3200.0	0.15	0.38	0.54	0.14	0.39	0.56	3200.0	30.60	30.15	29.82	31.70	31.16	30.65	34.68	34.14	33.52	33.10	32.73	32.31
3400.0	0.15	0.38	0.55	0.14	0.39	0.57	3400.0	30.01	29.68	29.24	31.02	30.53	30.06	33.85	33.39	32.86	32.27	32.30	31.59
3600.0	0.15	0.39	0.57	0.15	0.40	0.60	3600.0	29.12	29.15	28.51	30.35	29.92	29.46	33.03	32.68	32.21	31.36	31.47	30.87
3800.0	0.17	0.41	0.59	0.16	0.42	0.62	3800.0	28.43	28.44	27.90	29.76	29.33	28.87	32.31	32.03	31.57	30.56	30.57	30.14
4000.0	0.19	0.43	0.61	0.18	0.44	0.64	4000.0	27.88	27.62	27.35	29.15	28.77	28.32	31.49	31.32	30.90	29.93	29.68	29.55
4200.0	0.22	0.47	0.65	0.21	0.49	0.68	4200.0	27.07	26.75	26.66	28.53	28.19	27.77	30.78	30.69	30.33	29.22	28.84	28.93
4400.0	0.24	0.49	0.67	0.24	0.51	0.70	4400.0	26.33	26.04	26.17	27.91	27.57	27.17	29.93	29.92	29.59	28.48	28.41	28.51
4600.0	0.27	0.52	0.70	0.27	0.54	0.74	4600.0	26.12	25.97	25.68	27.36	27.05	26.73	29.26	29.24	29.10	28.13	28.21	27.98
4800.0	0.27	0.53	0.72	0.27	0.55	0.77	4800.0	25.29	25.46	25.04	26.78	26.50	26.17	28.60	28.61	28.49	27.15	27.40	27.20
5000.0	0.26	0.54	0.73	0.26	0.56	0.77	5000.0	24.87	24.72	24.63	26.09	25.93	25.68	27.72	27.89	27.83	26.40	26.52	26.60
5200.0	0.24	0.53	0.74	0.24	0.56	0.78	5200.0	24.16	24.01	24.03	25.53	25.36	25.12	27.16	27.21	27.20	25.63	25.72	25.88
5400.0	0.20	0.52	0.74	0.20	0.55	0.79	5400.0	23.30	23.29	23.32	24.95	24.80	24.68	26.41	26.51	26.56	24.71	24.86	25.05
5600.0	0.18	0.50	0.73	0.19	0.54	0.79	5600.0	22.77	22.55	22.72	24.21	24.22	24.09	25.68	25.90	25.95	24.04	24.10	24.37
5800.0	0.15	0.48	0.72	0.16	0.52	0.78	5800.0	22.15	22.10	22.10	23.62	23.58	23.54	25.07	25.15	25.18	23.50	23.56	23.56
6000.0	0.14	0.46	0.73	0.16	0.51	0.80	6000.0	21.39	21.54	21.35	22.97	23.01	22.99	24.40	24.51	24.70	22.57	22.90	22.79
6200.0	0.13	0.44	0.72	0.18	0.52	0.81	6200.0	20.46	20.89	20.74	22.42	22.51	22.51	23.97	23.96	24.17	21.63	22.16	22.02
6400.0	0.12	0.45	0.74	0.21	0.54	0.84	6400.0	19.96	20.22	20.27	21.76	21.99	21.94	23.30	23.38	23.43	21.18	21.36	21.50
6600.0	0.16	0.46	0.77	0.25	0.59	0.89	6600.0	19.46	19.55	19.87	21.09	21.40	21.30	22.55	22.81	22.76	20.72	20.76	21.19
6800.0	0.12	0.50	0.76	0.20	0.64	0.89	6800.0	19.61	19.24	19.66	20.55	20.85	20.93	21.83	22.17	22.19	21.00	20.44	20.83
7000.0	0.13	0.53	0.77	0.22	0.65	0.92	7000.0	19.03	19.04	19.24	20.20	20.34	20.52	21.34	21.48	21.69	20.19	20.21	20.28
7200.0	0.15	0.54	0.82	0.23	0.65	0.95	7200.0	18.72	18.92	19.07	19.66	19.95	20.02	20.50	20.99	21.16	19.79	20.04	20.14
7400.0	0.16	0.57	0.85	0.25	0.67	0.99	7400.0	18.24	18.59	18.72	19.46	19.59	19.79	20.18	20.44	20.71	19.28	19.54	19.62
7600.0	0.20	0.60	0.89	0.29	0.71	1.04	7600.0	17.87	18.19	18.31	19.07	19.27	19.52	19.73	20.16	20.50	18.68	19.19	19.30
7800.0	0.22	0.64	0.95	0.34	0.75	1.10	7800.0	17.30	17.79	17.93	18.83	18.99	19.29	19.27	19.77	20.15	17.75	18.65	18.78
8000.0	0.28	0.66	1.00	0.40	0.77	1.16	8000.0	16.96	17.45	17.54	18.41	18.61	18.84	18.92	19.37	19.89	17.48	18.24	18.42

Note:

State of:		RF Common to	
Control Voltage	Enable	RF1	RF2
HIGH	HIGH	ON	OFF
LOW	HIGH	OFF	ON
LOW/HIGH	LOW	Shutdown	

ON - Low insertion loss state
OFF - Isolation state



P.O. Box 350166, Brooklyn, New York 11235-0003 (718) 934-4500 • Fax (718) 332-4661 For detailed performance specs & shopping online see Mini-Circuits web site
The Design Engineers Search Engine Provides ACTUAL Data Instantly From MINI-CIRCUITS At: www.minicircuits.com

IF/RF MICROWAVE COMPONENTS

Typical Performance Data

RF FREQ (MHz)	VSWR (:1) @ VDD=+3V OVER TEMPERATURE (ON STATE, ENABLE-HIGH*)												RF FREQ (MHz)	VSWR (:1) @ VDD=+3V OVER TEMPERATURE (OFF STATE, ENABLE-HIGH*)					
	RF COM						RF1			RF2				RF1			RF2		
	Control HIGH*			Control LOW*			Control HIGH*			Control LOW*				Control LOW*			Control HIGH*		
	-45°C	+25°C	+85°C	-45°C	+25°C	+85°C	-45°C	+25°C	+85°C	-45°C	+25°C	+85°C		-45°C	+25°C	+85°C	-45°C	+25°C	+85°C
10.0	1.04	1.04	1.06	1.03	1.04	1.05	1.04	1.04	1.06	1.04	1.04	1.06	10.0	4.91	3.80	3.13	4.95	3.82	3.15
50.0	1.04	1.04	1.05	1.03	1.04	1.05	1.03	1.04	1.05	1.03	1.04	1.05	50.0	4.89	3.79	3.13	4.93	3.82	3.15
100.0	1.03	1.04	1.05	1.03	1.04	1.05	1.03	1.04	1.05	1.03	1.04	1.05	100.0	4.87	3.79	3.13	4.89	3.82	3.15
200.0	1.04	1.05	1.06	1.04	1.05	1.05	1.03	1.04	1.05	1.03	1.04	1.05	200.0	4.84	3.76	3.13	4.89	3.80	3.15
300.0	1.03	1.05	1.06	1.03	1.05	1.06	1.04	1.05	1.05	1.03	1.04	1.05	300.0	4.83	3.76	3.12	4.91	3.79	3.13
400.0	1.04	1.05	1.06	1.04	1.05	1.06	1.04	1.05	1.06	1.04	1.05	1.06	400.0	4.82	3.73	3.09	4.89	3.78	3.12
500.0	1.05	1.06	1.06	1.05	1.06	1.07	1.04	1.06	1.07	1.04	1.05	1.06	500.0	4.82	3.72	3.06	4.87	3.76	3.11
600.0	1.05	1.06	1.07	1.04	1.06	1.08	1.05	1.06	1.08	1.04	1.06	1.08	600.0	4.80	3.70	3.05	4.87	3.75	3.09
700.0	1.06	1.07	1.08	1.05	1.07	1.08	1.06	1.07	1.08	1.05	1.07	1.08	700.0	4.78	3.69	3.05	4.87	3.73	3.05
800.0	1.06	1.08	1.09	1.06	1.07	1.08	1.06	1.08	1.09	1.06	1.07	1.08	800.0	4.75	3.66	3.02	4.84	3.71	3.04
900.0	1.06	1.08	1.09	1.06	1.08	1.09	1.07	1.09	1.11	1.06	1.08	1.09	900.0	4.75	3.64	2.99	4.84	3.70	3.03
1000.0	1.07	1.09	1.09	1.07	1.09	1.10	1.08	1.10	1.11	1.07	1.09	1.10	1000.0	4.75	3.62	2.96	4.84	3.67	3.00
1200.0	1.08	1.10	1.11	1.08	1.09	1.11	1.09	1.11	1.12	1.08	1.10	1.11	1200.0	4.70	3.59	2.95	4.80	3.65	2.98
1400.0	1.11	1.11	1.12	1.10	1.11	1.11	1.12	1.13	1.14	1.11	1.12	1.13	1400.0	4.68	3.54	2.87	4.78	3.60	2.92
1600.0	1.11	1.12	1.12	1.11	1.12	1.12	1.14	1.14	1.14	1.12	1.13	1.13	1600.0	4.61	3.48	2.84	4.74	3.56	2.89
1800.0	1.13	1.13	1.13	1.13	1.13	1.13	1.15	1.15	1.16	1.14	1.14	1.14	1800.0	4.57	3.44	2.80	4.68	3.51	2.85
2000.0	1.15	1.14	1.13	1.16	1.15	1.13	1.17	1.16	1.16	1.16	1.16	1.15	2000.0	4.53	3.39	2.77	4.64	3.46	2.80
2200.0	1.16	1.15	1.13	1.16	1.15	1.14	1.17	1.17	1.16	1.17	1.16	1.15	2200.0	4.44	3.34	2.73	4.54	3.40	2.76
2400.0	1.17	1.15	1.12	1.17	1.16	1.14	1.17	1.16	1.15	1.17	1.15	1.14	2400.0	4.40	3.29	2.68	4.48	3.35	2.73
2600.0	1.14	1.13	1.11	1.15	1.14	1.12	1.15	1.15	1.13	1.14	1.14	1.12	2600.0	4.31	3.26	2.69	4.46	3.33	2.71
2800.0	1.11	1.10	1.09	1.13	1.12	1.12	1.11	1.11	1.11	1.12	1.11	1.09	2800.0	4.33	3.24	2.66	4.38	3.30	2.71
3000.0	1.09	1.08	1.07	1.12	1.10	1.10	1.10	1.09	1.09	1.10	1.08	1.07	3000.0	4.28	3.24	2.69	4.39	3.29	2.71
3200.0	1.05	1.06	1.07	1.07	1.08	1.09	1.03	1.05	1.07	1.03	1.04	1.06	3200.0	4.33	3.25	2.72	4.42	3.30	2.72
3400.0	1.05	1.07	1.08	1.06	1.08	1.09	1.04	1.07	1.09	1.03	1.04	1.06	3400.0	4.38	3.31	2.77	4.42	3.33	2.76
3600.0	1.12	1.13	1.13	1.10	1.12	1.12	1.12	1.12	1.13	1.09	1.09	1.10	3600.0	4.51	3.43	2.84	4.60	3.42	2.82
3800.0	1.19	1.19	1.17	1.19	1.17	1.15	1.18	1.18	1.17	1.18	1.15	1.14	3800.0	4.67	3.56	2.95	4.77	3.54	2.91
4000.0	1.27	1.25	1.23	1.24	1.22	1.20	1.27	1.25	1.23	1.23	1.21	1.19	4000.0	4.92	3.73	3.10	4.91	3.65	3.00
4200.0	1.35	1.33	1.29	1.33	1.30	1.27	1.35	1.33	1.29	1.32	1.29	1.26	4200.0	5.16	3.88	3.21	5.19	3.82	3.13
4400.0	1.42	1.38	1.32	1.39	1.34	1.29	1.42	1.38	1.33	1.40	1.35	1.30	4400.0	5.38	4.01	3.33	5.44	4.00	3.25
4600.0	1.49	1.44	1.38	1.46	1.41	1.36	1.49	1.44	1.39	1.46	1.41	1.36	4600.0	5.72	4.26	3.48	5.72	4.20	3.42
4800.0	1.50	1.46	1.40	1.46	1.43	1.38	1.50	1.47	1.41	1.47	1.44	1.39	4800.0	5.99	4.46	3.62	6.03	4.37	3.53
5000.0	1.52	1.47	1.41	1.48	1.44	1.39	1.52	1.48	1.42	1.48	1.46	1.41	5000.0	6.37	4.64	3.74	6.24	4.55	3.68
5200.0	1.48	1.46	1.40	1.45	1.43	1.39	1.48	1.46	1.41	1.46	1.44	1.40	5200.0	6.51	4.73	3.81	6.49	4.66	3.73
5400.0	1.40	1.41	1.37	1.36	1.38	1.35	1.42	1.42	1.38	1.39	1.40	1.37	5400.0	6.73	4.83	3.85	6.63	4.78	3.80
5600.0	1.39	1.37	1.33	1.33	1.34	1.31	1.38	1.38	1.35	1.33	1.36	1.34	5600.0	6.86	4.88	3.90	6.68	4.84	3.89
5800.0	1.30	1.30	1.27	1.25	1.25	1.23	1.31	1.30	1.28	1.28	1.27	1.26	5800.0	6.89	4.87	3.86	6.86	4.80	3.79
6000.0	1.22	1.23	1.21	1.16	1.18	1.17	1.23	1.23	1.22	1.18	1.21	1.20	6000.0	6.89	4.86	3.83	6.61	4.75	3.75
6200.0	1.16	1.14	1.12	1.11	1.11	1.09	1.16	1.15	1.12	1.15	1.14	1.13	6200.0	6.71	4.74	3.73	6.66	4.69	3.68
6400.0	1.08	1.07	1.08	1.04	1.03	1.03	1.11	1.07	1.07	1.11	1.07	1.05	6400.0	6.44	4.63	3.58	6.56	4.56	3.52
6600.0	1.04	1.01	1.01	1.04	1.04	1.03	1.09	1.03	1.02	1.07	1.04	1.03	6600.0	6.07	4.43	3.49	6.17	4.42	3.48
6800.0	1.05	1.08	1.08	1.04	1.11	1.12	1.08	1.10	1.09	1.07	1.07	1.09	6800.0	5.91	4.26	3.35	6.19	4.27	3.29
7000.0	1.13	1.15	1.14	1.13	1.17	1.17	1.16	1.17	1.14	1.11	1.13	1.14	7000.0	5.83	4.09	3.29	6.05	4.18	3.22
7200.0	1.19	1.23	1.23	1.20	1.24	1.24	1.20	1.23	1.23	1.18	1.20	1.19	7200.0	5.49	3.94	3.14	5.68	4.04	3.19
7400.0	1.23	1.28	1.26	1.25	1.30	1.31	1.24	1.28	1.26	1.22	1.26	1.27	7400.0	5.41	3.86	3.11	5.61	3.88	3.03
7600.0	1.32	1.31	1.31	1.32	1.34	1.33	1.32	1.32	1.30	1.26	1.30	1.28	7600.0	5.14	3.77	3.06	5.44	3.81	3.00
7800.0	1.36	1.37	1.37	1.40	1.40	1.40	1.35	1.36	1.35	1.36	1.35	1.33	7800.0	5.14	3.67	2.95	5.02	3.67	2.95
8000.0	1.41	1.36	1.32	1.44	1.39	1.35	1.41	1.36	1.32	1.37	1.34	1.30	8000.0	4.86	3.64	2.99	5.06	3.60	2.89

*Note:

State of:		RF Common to	
Control Voltage	Enable	RF1	RF2
HIGH	HIGH	ON	OFF
LOW	HIGH	OFF	ON
LOW/HIGH	LOW	Shutdown	

ON - Low insertion loss state
OFF - Isolation state



P.O. Box 350166, Brooklyn, New York 11235-0003 (718) 934-4500 • Fax (718) 332-4661 For detailed performance specs & shopping online see Mini-Circuits web site



The Design Engineers Search Engine Provides ACTUAL Data Instantly From MINI-CIRCUITS At: www.minicircuits.com

IF/RF MICROWAVE COMPONENTS

REV. OR JSW2-63DR+

3/13/2013

Page 5 of 9

Typical Performance Data

RF FREQ (MHz)	INSERTION LOSS (dB) @ VDD=+2.3V OVER TEMPERATURE (ENABLE-HIGH*)						RF FREQ (MHz)	ISOLATION (dB) @ VDD=+2.3V OVER TEMPERATURE (ENABLE-HIGH*)											
	RF COM-RF1			RF COM-RF2				RF COM-RF1			RF COM-RF2			RF1-RF2 Control LOW*			RF1-RF2 Control HIGH*		
	-45°C	+25°C	+85°C	-45°C	+25°C	+85°C		-45°C	+25°C	+85°C	-45°C	+25°C	+85°C	-45°C	+25°C	+85°C	-45°C	+25°C	+85°C
10.0	0.23	0.28	0.32	0.22	0.27	0.32	10.0	69.79	67.16	69.13	85.36	69.44	85.68	86.25	75.45	70.86	74.90	80.45	76.60
50.0	0.23	0.28	0.32	0.22	0.28	0.32	50.0	71.26	67.11	67.45	69.14	70.00	66.33	74.17	71.37	71.49	73.84	70.02	72.28
100.0	0.23	0.28	0.33	0.23	0.28	0.33	100.0	64.52	62.79	61.53	64.44	62.80	61.55	70.09	66.92	65.11	69.97	67.06	65.09
200.0	0.23	0.29	0.34	0.23	0.28	0.33	200.0	58.25	56.79	55.63	58.06	56.64	55.54	64.23	61.31	59.28	63.53	60.93	58.99
300.0	0.22	0.29	0.35	0.22	0.29	0.35	300.0	54.42	53.09	52.00	54.52	53.10	52.06	60.43	57.77	56.01	59.90	57.40	55.76
400.0	0.22	0.30	0.36	0.21	0.29	0.36	400.0	52.02	50.60	49.56	51.91	50.58	49.54	57.90	55.11	53.42	57.12	54.81	53.11
500.0	0.22	0.30	0.36	0.21	0.30	0.36	500.0	49.97	48.63	47.58	49.88	48.56	47.57	55.68	53.18	51.46	55.08	52.82	51.09
600.0	0.21	0.30	0.37	0.21	0.30	0.38	600.0	48.31	46.99	45.98	48.32	47.01	46.00	53.87	51.49	49.79	53.24	51.04	49.43
700.0	0.21	0.31	0.38	0.20	0.31	0.39	700.0	46.89	45.62	44.61	46.91	45.61	44.64	52.45	50.16	48.43	51.74	49.60	48.07
800.0	0.21	0.31	0.39	0.20	0.31	0.39	800.0	45.64	44.39	43.42	45.71	44.48	43.45	51.05	48.84	47.22	50.36	48.35	46.80
900.0	0.20	0.31	0.40	0.19	0.31	0.40	900.0	44.55	43.32	42.37	44.62	43.41	42.44	49.79	47.70	46.12	49.09	47.12	45.69
1000.0	0.20	0.32	0.41	0.19	0.32	0.41	1000.0	43.55	42.35	41.42	43.67	42.45	41.49	48.70	46.67	45.18	47.89	46.09	44.72
1200.0	0.20	0.32	0.42	0.18	0.32	0.42	1200.0	41.76	40.62	39.76	41.94	40.78	39.85	46.69	44.89	43.45	45.84	44.24	42.95
1400.0	0.19	0.33	0.44	0.18	0.33	0.44	1400.0	40.22	39.16	38.32	40.46	39.36	38.49	44.96	43.28	41.95	44.06	42.62	41.41
1600.0	0.19	0.34	0.45	0.18	0.34	0.46	1600.0	38.79	37.82	37.06	39.13	38.10	37.25	43.40	41.86	40.67	42.33	40.99	40.04
1800.0	0.19	0.34	0.46	0.18	0.35	0.47	1800.0	37.56	36.65	35.94	37.92	36.99	36.19	41.94	40.59	39.44	40.86	39.77	38.79
2000.0	0.19	0.35	0.47	0.18	0.36	0.49	2000.0	36.35	35.56	34.89	36.84	35.95	35.20	40.68	39.46	38.38	39.52	38.54	37.66
2200.0	0.19	0.36	0.49	0.18	0.37	0.50	2200.0	35.30	34.55	33.95	35.80	35.00	34.29	39.53	38.42	37.43	38.23	37.37	36.60
2400.0	0.19	0.37	0.50	0.18	0.37	0.52	2400.0	34.26	33.63	33.04	34.88	34.15	33.48	38.41	37.44	36.54	37.06	36.35	35.63
2600.0	0.18	0.37	0.51	0.17	0.38	0.53	2600.0	33.27	32.72	32.21	34.02	33.33	32.69	37.39	36.54	35.71	35.95	35.37	34.74
2800.0	0.17	0.37	0.52	0.17	0.38	0.54	2800.0	32.35	31.84	31.38	33.15	32.55	31.98	36.45	35.71	34.96	34.99	34.46	33.93
3000.0	0.16	0.37	0.53	0.16	0.38	0.55	3000.0	31.44	31.01	30.59	32.40	31.84	31.28	35.47	34.87	34.19	33.84	33.50	33.02
3200.0	0.16	0.38	0.54	0.15	0.39	0.57	3200.0	30.60	30.35	29.84	31.68	31.13	30.61	34.65	34.13	33.48	33.11	32.83	32.32
3400.0	0.15	0.38	0.56	0.15	0.39	0.58	3400.0	30.01	29.58	29.25	30.99	30.49	30.03	33.84	33.37	32.82	32.25	31.96	31.60
3600.0	0.16	0.39	0.57	0.16	0.41	0.60	3600.0	29.07	28.94	28.52	30.32	29.90	29.44	33.02	32.66	32.16	31.29	31.17	30.85
3800.0	0.17	0.41	0.59	0.17	0.42	0.62	3800.0	28.42	28.25	27.88	29.73	29.31	28.83	32.28	32.00	31.54	30.55	30.55	30.12
4000.0	0.20	0.44	0.62	0.19	0.45	0.64	4000.0	27.90	27.54	27.34	29.13	28.72	28.29	31.48	31.26	30.89	29.95	29.76	29.51
4200.0	0.22	0.47	0.65	0.22	0.49	0.68	4200.0	27.05	26.70	26.64	28.52	28.13	27.73	30.77	30.60	30.30	29.19	29.01	28.91
4400.0	0.25	0.49	0.67	0.25	0.51	0.70	4400.0	26.36	26.28	26.13	27.91	27.57	27.15	29.94	29.95	29.57	28.46	28.50	28.47
4600.0	0.27	0.52	0.71	0.28	0.54	0.74	4600.0	26.10	25.84	25.66	27.34	27.01	26.70	29.26	29.26	29.07	28.12	28.04	27.96
4800.0	0.27	0.53	0.72	0.28	0.55	0.77	4800.0	25.27	25.30	25.02	26.77	26.47	26.15	28.60	28.55	28.47	27.11	27.55	27.18
5000.0	0.27	0.54	0.73	0.27	0.56	0.77	5000.0	24.85	24.76	24.59	26.09	25.93	25.65	27.74	27.83	27.82	26.38	26.45	26.57
5200.0	0.24	0.53	0.74	0.25	0.56	0.78	5200.0	24.15	24.03	24.01	25.51	25.33	25.10	27.15	27.17	27.18	25.65	25.83	25.87
5400.0	0.21	0.51	0.74	0.21	0.55	0.79	5400.0	23.32	23.41	23.31	24.94	24.75	24.65	26.42	26.43	26.55	24.72	25.04	25.02
5600.0	0.19	0.50	0.73	0.20	0.54	0.80	5600.0	22.75	22.68	22.71	24.21	24.22	24.07	25.68	25.90	25.94	24.06	24.19	24.39
5800.0	0.16	0.48	0.73	0.17	0.52	0.78	5800.0	22.13	21.96	22.06	23.63	23.61	23.52	25.07	25.16	25.16	23.49	23.38	23.51
6000.0	0.14	0.46	0.73	0.18	0.52	0.80	6000.0	21.34	21.46	21.34	22.96	23.01	22.97	24.41	24.51	24.68	22.52	22.60	22.78
6200.0	0.14	0.45	0.72	0.19	0.53	0.82	6200.0	20.44	20.64	20.72	22.41	22.52	22.49	23.97	23.99	24.16	21.60	21.60	21.99
6400.0	0.13	0.46	0.74	0.21	0.57	0.85	6400.0	19.99	19.92	20.22	21.76	21.90	21.91	23.26	23.28	23.39	21.19	21.39	21.50
6600.0	0.16	0.48	0.77	0.27	0.59	0.89	6600.0	19.45	19.87	19.87	21.10	21.22	21.27	22.58	22.59	22.74	20.69	21.27	21.18
6800.0	0.13	0.48	0.76	0.22	0.61	0.89	6800.0	19.50	19.43	19.65	20.59	20.73	20.89	21.86	22.00	22.17	20.88	20.71	20.74
7000.0	0.14	0.50	0.78	0.24	0.60	0.92	7000.0	19.01	19.26	19.23	20.21	20.38	20.52	21.36	21.40	21.68	20.22	20.41	20.28
7200.0	0.16	0.54	0.82	0.25	0.64	0.95	7200.0	18.71	18.87	19.05	19.69	20.01	20.03	20.52	21.04	21.15	19.79	20.16	20.15
7400.0	0.17	0.56	0.85	0.27	0.65	0.99	7400.0	18.24	18.58	18.73	19.47	19.70	19.78	20.21	20.57	20.69	19.21	19.53	19.61
7600.0	0.20	0.59	0.89	0.30	0.72	1.04	7600.0	17.86	17.95	18.30	19.10	19.39	19.49	19.76	20.26	20.49	18.68	19.07	19.31
7800.0	0.23	0.64	0.95	0.35	0.78	1.10	7800.0	17.37	17.66	17.92	18.83	19.06	19.31	19.28	19.90	20.15	17.83	18.26	18.80
8000.0	0.28	0.66	1.00	0.41	0.81	1.16	8000.0	16.99	17.42	17.53	18.39	18.59	18.82	18.89	19.64	19.87	17.52	17.97	18.41

*Note:

Control Voltage	State of:		RF Common to	
	Enable	RF1	RF2	
HIGH	HIGH	ON	OFF	
LOW	HIGH	OFF	ON	
LOW/HIGH	LOW	Shutdown		

ON - Low insertion loss state
OFF - Isolation state



P.O. Box 350166, Brooklyn, New York 11235-0003 (718) 934-4500 • Fax (718) 332-4661 For detailed performance specs & shopping online see Mini-Circuits web site
The Design Engineers Search Engine Provides ACTUAL Data Instantly From MINI-CIRCUITS At: www.minicircuits.com

IF/RF MICROWAVE COMPONENTS

Typical Performance Data

RF FREQ (MHz)	VSWR (:1) @ VDD=+2.3V OVER TEMPERATURE (ON STATE, ENABLE-HIGH*)												RF FREQ (MHz)	VSWR (:1) @ VDD=+2.3V OVER TEMPERATURE (OFF STATE, ENABLE-HIGH*)					
	RF COM						RF1			RF2				RF1			RF2		
	Control HIGH*			Control LOW*			Control HIGH*			Control LOW*				Control LOW*			Control HIGH*		
	-45°C	+25°C	+85°C	-45°C	+25°C	+85°C	-45°C	+25°C	+85°C	-45°C	+25°C	+85°C		-45°C	+25°C	+85°C	-45°C	+25°C	+85°C
10.0	1.04	1.04	1.06	1.03	1.04	1.05	1.04	1.05	1.06	1.04	1.04	1.06	10.0	4.82	3.76	3.10	4.86	3.79	3.12
50.0	1.04	1.04	1.05	1.03	1.04	1.05	1.03	1.04	1.06	1.03	1.04	1.06	50.0	4.80	3.76	3.09	4.84	3.79	3.12
100.0	1.03	1.04	1.05	1.03	1.04	1.05	1.03	1.04	1.05	1.03	1.04	1.05	100.0	4.78	3.75	3.10	4.82	3.78	3.12
200.0	1.04	1.05	1.06	1.04	1.05	1.05	1.03	1.04	1.05	1.03	1.04	1.05	200.0	4.75	3.73	3.10	4.80	3.76	3.12
300.0	1.03	1.05	1.06	1.04	1.05	1.06	1.04	1.05	1.05	1.03	1.04	1.05	300.0	4.74	3.72	3.08	4.82	3.76	3.10
400.0	1.04	1.05	1.06	1.04	1.05	1.06	1.04	1.05	1.06	1.04	1.05	1.06	400.0	4.74	3.70	3.06	4.82	3.75	3.08
500.0	1.05	1.06	1.06	1.05	1.06	1.07	1.04	1.06	1.07	1.04	1.05	1.07	500.0	4.73	3.68	3.03	4.78	3.73	3.08
600.0	1.05	1.06	1.07	1.04	1.06	1.08	1.05	1.06	1.08	1.05	1.06	1.08	600.0	4.72	3.67	3.02	4.78	3.71	3.05
700.0	1.06	1.07	1.09	1.06	1.07	1.08	1.06	1.07	1.08	1.05	1.07	1.08	700.0	4.69	3.65	3.01	4.78	3.69	3.02
800.0	1.06	1.08	1.09	1.06	1.07	1.08	1.06	1.08	1.09	1.06	1.07	1.08	800.0	4.67	3.62	2.99	4.75	3.67	3.01
900.0	1.06	1.08	1.09	1.06	1.08	1.09	1.07	1.09	1.11	1.06	1.08	1.09	900.0	4.67	3.60	2.95	4.75	3.66	3.00
1000.0	1.07	1.09	1.10	1.07	1.09	1.10	1.08	1.10	1.11	1.08	1.09	1.10	1000.0	4.66	3.58	2.93	4.75	3.65	2.97
1200.0	1.08	1.10	1.11	1.08	1.10	1.11	1.09	1.11	1.12	1.08	1.10	1.11	1200.0	4.61	3.56	2.92	4.70	3.61	2.95
1400.0	1.11	1.11	1.12	1.11	1.11	1.11	1.12	1.13	1.14	1.11	1.12	1.13	1400.0	4.59	3.50	2.84	4.69	3.57	2.89
1600.0	1.11	1.12	1.12	1.11	1.12	1.12	1.14	1.14	1.14	1.12	1.13	1.13	1600.0	4.53	3.46	2.82	4.66	3.53	2.86
1800.0	1.13	1.13	1.13	1.13	1.13	1.13	1.15	1.15	1.16	1.14	1.14	1.14	1800.0	4.48	3.41	2.77	4.59	3.48	2.82
2000.0	1.15	1.14	1.13	1.16	1.15	1.13	1.17	1.16	1.16	1.16	1.16	1.15	2000.0	4.44	3.36	2.73	4.56	3.43	2.77
2200.0	1.16	1.15	1.13	1.16	1.15	1.14	1.17	1.17	1.16	1.17	1.16	1.15	2200.0	4.36	3.31	2.70	4.45	3.37	2.73
2400.0	1.17	1.15	1.12	1.17	1.15	1.14	1.17	1.16	1.16	1.17	1.16	1.14	2400.0	4.31	3.26	2.66	4.40	3.33	2.71
2600.0	1.14	1.13	1.11	1.15	1.14	1.12	1.15	1.14	1.13	1.14	1.14	1.12	2600.0	4.22	3.22	2.66	4.38	3.30	2.69
2800.0	1.11	1.10	1.09	1.13	1.12	1.12	1.11	1.11	1.11	1.12	1.11	1.09	2800.0	4.25	3.20	2.63	4.29	3.27	2.69
3000.0	1.09	1.07	1.07	1.11	1.10	1.10	1.10	1.09	1.09	1.10	1.08	1.07	3000.0	4.19	3.21	2.67	4.30	3.26	2.69
3200.0	1.05	1.06	1.07	1.07	1.08	1.09	1.04	1.06	1.07	1.03	1.04	1.06	3200.0	4.24	3.24	2.69	4.34	3.27	2.69
3400.0	1.05	1.07	1.08	1.06	1.08	1.09	1.04	1.07	1.09	1.03	1.04	1.06	3400.0	4.30	3.30	2.74	4.34	3.30	2.73
3600.0	1.12	1.12	1.13	1.10	1.11	1.12	1.12	1.12	1.13	1.09	1.09	1.10	3600.0	4.43	3.38	2.82	4.51	3.39	2.79
3800.0	1.19	1.18	1.17	1.19	1.17	1.15	1.18	1.18	1.17	1.18	1.15	1.14	3800.0	4.57	3.51	2.92	4.67	3.50	2.88
4000.0	1.27	1.25	1.23	1.24	1.22	1.20	1.27	1.25	1.23	1.23	1.21	1.19	4000.0	4.83	3.68	3.06	4.80	3.62	2.97
4200.0	1.35	1.33	1.29	1.32	1.30	1.27	1.35	1.32	1.29	1.32	1.29	1.26	4200.0	5.06	3.84	3.18	5.09	3.79	3.10
4400.0	1.42	1.38	1.32	1.39	1.34	1.29	1.42	1.38	1.33	1.39	1.35	1.30	4400.0	5.28	3.99	3.30	5.34	3.95	3.22
4600.0	1.49	1.44	1.38	1.46	1.41	1.36	1.49	1.44	1.39	1.46	1.41	1.36	4600.0	5.61	4.22	3.45	5.59	4.15	3.38
4800.0	1.50	1.46	1.40	1.45	1.43	1.38	1.50	1.46	1.41	1.47	1.44	1.39	4800.0	5.87	4.40	3.58	5.91	4.33	3.50
5000.0	1.52	1.48	1.41	1.48	1.45	1.39	1.52	1.49	1.42	1.48	1.46	1.41	5000.0	6.24	4.60	3.70	6.11	4.51	3.65
5200.0	1.48	1.46	1.40	1.45	1.44	1.39	1.48	1.46	1.41	1.46	1.44	1.40	5200.0	6.37	4.69	3.77	6.35	4.62	3.70
5400.0	1.40	1.41	1.37	1.36	1.38	1.35	1.42	1.42	1.38	1.39	1.40	1.38	5400.0	6.58	4.80	3.81	6.49	4.74	3.76
5600.0	1.39	1.37	1.33	1.33	1.34	1.31	1.38	1.38	1.35	1.33	1.36	1.35	5600.0	6.71	4.87	3.87	6.53	4.80	3.86
5800.0	1.30	1.30	1.27	1.25	1.26	1.24	1.31	1.30	1.28	1.28	1.27	1.26	5800.0	6.73	4.88	3.82	6.71	4.78	3.75
6000.0	1.22	1.23	1.21	1.16	1.18	1.17	1.23	1.23	1.22	1.18	1.20	1.20	6000.0	6.73	4.86	3.80	6.46	4.72	3.72
6200.0	1.16	1.14	1.12	1.11	1.10	1.09	1.16	1.14	1.12	1.15	1.14	1.13	6200.0	6.56	4.69	3.69	6.51	4.64	3.65
6400.0	1.08	1.08	1.08	1.04	1.03	1.03	1.10	1.08	1.07	1.11	1.07	1.05	6400.0	6.32	4.55	3.54	6.42	4.52	3.49
6600.0	1.04	1.02	1.01	1.04	1.03	1.03	1.08	1.04	1.02	1.07	1.04	1.03	6600.0	5.93	4.35	3.46	6.03	4.39	3.45
6800.0	1.05	1.08	1.08	1.05	1.10	1.12	1.08	1.09	1.09	1.07	1.07	1.09	6800.0	5.77	4.23	3.33	6.07	4.22	3.26
7000.0	1.13	1.16	1.14	1.14	1.18	1.17	1.16	1.16	1.14	1.11	1.14	1.14	7000.0	5.70	4.09	3.25	5.91	4.14	3.20
7200.0	1.20	1.23	1.23	1.20	1.24	1.24	1.20	1.23	1.23	1.18	1.20	1.19	7200.0	5.36	3.92	3.11	5.54	4.01	3.16
7400.0	1.23	1.28	1.27	1.25	1.31	1.31	1.24	1.28	1.26	1.23	1.27	1.27	7400.0	5.31	3.85	3.09	5.49	3.86	3.00
7600.0	1.32	1.31	1.31	1.32	1.33	1.33	1.32	1.32	1.30	1.26	1.29	1.28	7600.0	5.03	3.74	3.03	5.33	3.79	2.98
7800.0	1.36	1.37	1.38	1.40	1.40	1.41	1.34	1.37	1.36	1.36	1.36	1.33	7800.0	5.03	3.64	2.92	4.92	3.65	2.93
8000.0	1.41	1.35	1.32	1.44	1.39	1.35	1.41	1.36	1.32	1.37	1.34	1.30	8000.0	4.75	3.59	2.97	4.95	3.58	2.86

*Note:

State of:		RF Common to	
Control Voltage	Enable	RF1	RF2
HIGH	HIGH	ON	OFF
LOW	HIGH	OFF	ON
LOW/HIGH	LOW	Shutdown	

ON - Low insertion loss state
 OFF - Isolation state



P.O. Box 350166, Brooklyn, New York 11235-0003 (718) 934-4500 • Fax (718) 332-4661 For detailed performance specs & shopping online see Mini-Circuits web site
 The Design Engineers Search Engine Provides ACTUAL Data Instantly From MINI-CIRCUITS At: www.minicircuits.com



IF/RF MICROWAVE COMPONENTS

Typical Performance Data

RF FREQ (MHz)	INSERTION LOSS (dB) @ VDD=+4.8V OVER TEMPERATURE (ENABLE-HIGH*)						RF FREQ (MHz)	ISOLATION (dB) @ VDD=+4.8V OVER TEMPERATURE (ENABLE-HIGH*)											
	RF COM-RF1			RF COM-RF2				RF COM-RF1			RF COM-RF2			RF1-RF2 Control LOW*			RF1-RF2 Control HIGH*		
	-45°C	+25°C	+85°C	-45°C	+25°C	+85°C		-45°C	+25°C	+85°C	-45°C	+25°C	+85°C	-45°C	+25°C	+85°C	-45°C	+25°C	+85°C
10.0	0.23	0.28	0.33	0.22	0.27	0.32	10.0	69.16	72.45	78.18	77.43	80.82	71.47	80.56	94.78	68.29	72.72	82.09	75.54
50.0	0.23	0.28	0.32	0.22	0.27	0.32	50.0	75.09	68.51	66.38	70.01	68.25	66.40	73.12	70.20	73.67	80.69	70.43	70.92
100.0	0.23	0.28	0.33	0.23	0.28	0.32	100.0	64.55	62.86	61.86	64.28	62.90	61.61	70.41	67.09	65.34	70.04	67.10	65.12
200.0	0.23	0.29	0.33	0.23	0.28	0.33	200.0	58.10	56.79	55.69	58.13	56.74	55.58	64.26	61.29	59.44	63.63	61.06	59.24
300.0	0.23	0.29	0.34	0.22	0.29	0.34	300.0	54.51	53.19	52.11	54.42	53.08	52.05	60.46	57.65	56.05	59.97	57.38	55.71
400.0	0.22	0.29	0.35	0.22	0.29	0.35	400.0	51.99	50.63	49.61	51.88	50.56	49.59	57.96	55.26	53.52	57.31	54.88	53.13
500.0	0.22	0.30	0.36	0.21	0.30	0.36	500.0	49.93	48.68	47.62	49.92	48.59	47.66	55.68	53.37	51.54	55.11	52.76	51.20
600.0	0.22	0.30	0.37	0.21	0.30	0.37	600.0	48.32	47.06	46.01	48.29	47.02	46.02	53.92	51.56	49.87	53.26	51.16	49.53
700.0	0.21	0.31	0.38	0.21	0.31	0.38	700.0	46.88	45.66	44.68	46.93	45.69	44.66	52.42	50.21	48.52	51.74	49.66	48.20
800.0	0.21	0.31	0.39	0.20	0.31	0.39	800.0	45.66	44.45	43.49	45.71	44.48	43.53	51.11	48.90	47.28	50.44	48.39	46.92
900.0	0.21	0.31	0.40	0.20	0.31	0.40	900.0	44.58	43.38	42.42	44.63	43.45	42.49	49.83	47.74	46.21	49.06	47.20	45.81
1000.0	0.20	0.32	0.41	0.19	0.31	0.41	1000.0	43.56	42.40	41.49	43.63	42.48	41.55	48.67	46.72	45.27	47.91	46.19	44.77
1200.0	0.20	0.32	0.42	0.19	0.32	0.42	1200.0	41.75	40.69	39.80	41.92	40.84	39.91	46.72	44.96	43.53	45.79	44.30	43.02
1400.0	0.20	0.33	0.43	0.19	0.33	0.44	1400.0	40.22	39.21	38.37	40.46	39.41	38.55	44.98	43.32	42.03	44.07	42.61	41.45
1600.0	0.19	0.34	0.45	0.18	0.34	0.45	1600.0	38.79	37.87	37.10	39.14	38.13	37.32	43.39	41.93	40.74	42.35	41.16	40.09
1800.0	0.19	0.34	0.46	0.18	0.35	0.47	1800.0	37.59	36.68	35.96	37.92	36.99	36.23	41.96	40.66	39.51	40.91	39.81	38.84
2000.0	0.20	0.35	0.47	0.19	0.36	0.49	2000.0	36.37	35.61	34.93	36.85	35.97	35.23	40.70	39.48	38.44	39.50	38.53	37.70
2200.0	0.19	0.36	0.49	0.18	0.37	0.50	2200.0	35.31	34.60	33.98	35.83	35.02	34.34	39.53	38.45	37.50	38.23	37.41	36.65
2400.0	0.19	0.37	0.50	0.19	0.37	0.51	2400.0	34.26	33.63	33.07	34.89	34.16	33.53	38.44	37.47	36.61	37.09	36.33	35.68
2600.0	0.18	0.37	0.51	0.18	0.38	0.53	2600.0	33.29	32.71	32.24	34.03	33.34	32.73	37.40	36.57	35.76	35.97	35.29	34.79
2800.0	0.17	0.37	0.52	0.17	0.38	0.54	2800.0	32.35	31.87	31.41	33.16	32.59	32.02	36.46	35.75	35.01	34.97	34.40	33.95
3000.0	0.17	0.37	0.53	0.16	0.38	0.55	3000.0	31.45	31.03	30.59	32.40	31.85	31.32	35.48	34.90	34.23	33.83	33.45	33.02
3200.0	0.16	0.38	0.54	0.16	0.39	0.56	3200.0	30.54	30.29	29.83	31.68	31.15	30.64	34.65	34.16	33.52	33.10	32.72	32.33
3400.0	0.16	0.38	0.55	0.15	0.39	0.57	3400.0	30.01	29.48	29.27	31.01	30.51	30.06	33.84	33.38	32.85	32.28	31.91	31.63
3600.0	0.16	0.40	0.57	0.16	0.41	0.59	3600.0	29.01	28.74	28.54	30.33	29.88	29.46	33.03	32.65	32.19	31.31	31.18	30.87
3800.0	0.18	0.41	0.59	0.18	0.43	0.61	3800.0	28.42	28.24	27.91	29.74	29.31	28.86	32.29	32.00	31.56	30.56	30.61	30.15
4000.0	0.20	0.44	0.61	0.19	0.45	0.64	4000.0	27.92	27.68	27.36	29.14	28.72	28.32	31.49	31.23	30.92	29.96	29.97	29.54
4200.0	0.23	0.47	0.64	0.23	0.48	0.68	4200.0	27.08	27.13	26.67	28.52	28.19	27.76	30.78	30.65	30.32	29.23	29.36	28.94
4400.0	0.26	0.48	0.67	0.26	0.49	0.70	4400.0	26.41	26.62	26.13	27.91	27.61	27.17	29.94	29.89	29.60	28.50	28.70	28.50
4600.0	0.28	0.52	0.70	0.29	0.53	0.74	4600.0	26.07	25.98	25.69	27.36	27.05	26.73	29.27	29.23	29.10	28.07	27.97	27.98
4800.0	0.28	0.52	0.72	0.28	0.54	0.76	4800.0	25.30	25.27	25.04	26.77	26.52	26.17	28.61	28.61	28.49	27.12	27.16	27.22
5000.0	0.28	0.54	0.73	0.28	0.55	0.77	5000.0	24.87	24.67	24.62	26.10	25.95	25.68	27.74	27.89	27.83	26.41	26.43	26.58
5200.0	0.25	0.53	0.73	0.26	0.56	0.78	5200.0	24.16	23.80	24.03	25.51	25.38	25.13	27.15	27.30	27.20	25.64	25.47	25.87
5400.0	0.22	0.52	0.74	0.22	0.55	0.79	5400.0	23.33	23.10	23.32	24.95	24.81	24.68	26.43	26.60	26.57	24.71	24.67	25.04
5600.0	0.20	0.50	0.73	0.21	0.55	0.79	5600.0	22.77	22.48	22.71	24.22	24.21	24.10	25.68	25.97	25.95	24.09	24.05	24.40
5800.0	0.16	0.48	0.72	0.18	0.53	0.78	5800.0	22.16	22.02	22.06	23.63	23.54	23.55	25.08	25.22	25.18	23.48	23.57	23.54
6000.0	0.15	0.47	0.72	0.18	0.53	0.80	6000.0	21.34	21.42	21.39	22.97	22.95	23.00	24.42	24.55	24.70	22.54	22.96	22.82
6200.0	0.14	0.45	0.72	0.20	0.52	0.81	6200.0	20.45	20.94	20.73	22.44	22.42	22.53	23.97	23.91	24.16	21.62	22.39	22.01
6400.0	0.14	0.44	0.74	0.22	0.52	0.84	6400.0	20.00	20.42	20.26	21.78	21.88	21.95	23.27	23.24	23.41	21.20	21.72	21.51
6600.0	0.17	0.45	0.76	0.27	0.54	0.89	6600.0	19.44	19.98	19.82	21.13	21.37	21.27	22.60	22.64	22.79	20.76	21.22	21.10
6800.0	0.14	0.47	0.77	0.24	0.58	0.90	6800.0	19.46	19.47	19.61	20.60	20.92	20.90	21.88	22.06	22.19	20.85	20.54	20.68
7000.0	0.15	0.50	0.77	0.25	0.62	0.92	7000.0	19.01	19.01	19.22	20.24	20.46	20.53	21.39	21.52	21.70	20.20	20.09	20.27
7200.0	0.17	0.54	0.82	0.26	0.67	0.94	7200.0	18.72	18.62	19.05	19.70	20.12	20.03	20.53	21.14	21.15	19.80	19.65	20.12
7400.0	0.18	0.59	0.85	0.28	0.72	0.99	7400.0	18.25	18.34	18.69	19.48	19.66	19.80	20.24	20.61	20.68	19.21	19.23	19.58
7600.0	0.22	0.62	0.89	0.31	0.75	1.03	7600.0	17.86	17.98	18.31	19.12	19.26	19.49	19.79	20.27	20.48	18.66	18.91	19.35
7800.0	0.24	0.66	0.95	0.36	0.79	1.09	7800.0	17.37	17.74	17.92	18.84	18.92	19.31	19.28	19.77	20.15	17.81	18.55	18.78
8000.0	0.29	0.68	0.99	0.43	0.80	1.16	8000.0	16.98	17.51	17.53	18.40	18.45	18.82	18.89	19.36	19.86	17.52	18.24	18.38

*Note:

State of:		RF Common to	
Control Voltage	Enable	RF1	RF2
HIGH	HIGH	ON	OFF
LOW	HIGH	OFF	ON
LOW/HIGH	LOW	Shutdown	

ON - Low insertion loss state
OFF - Isolation state



P.O. Box 350166, Brooklyn, New York 11235-0003 (718) 934-4500 • Fax (718) 332-4661 For detailed performance specs & shopping online see Mini-Circuits web site



The Design Engineers Search Engine Provides ACTUAL Data Instantly From MINI-CIRCUITS At: www.minicircuits.com

IF/RF MICROWAVE COMPONENTS

Typical Performance Data

RF FREQ (MHz)	VSWR (:1) @ VDD=+4.8V OVER TEMPERATURE (ON STATE, ENABLE-HIGH*)												RF FREQ (MHz)	VSWR (:1) @ VDD=+4.8V OVER TEMPERATURE (OFF STATE, ENABLE-HIGH*)					
	RF COM						RF1			RF2				RF1			RF2		
	Control HIGH*			Control LOW*			Control HIGH*			Control LOW*				Control LOW*			Control HIGH*		
	-45°C	+25°C	+85°C	-45°C	+25°C	+85°C	-45°C	+25°C	+85°C	-45°C	+25°C	+85°C		-45°C	+25°C	+85°C	-45°C	+25°C	+85°C
10.0	1.04	1.05	1.06	1.03	1.04	1.05	1.04	1.05	1.06	1.04	1.05	1.06	10.0	4.87	3.79	3.13	4.95	3.81	3.15
50.0	1.04	1.04	1.05	1.03	1.04	1.05	1.03	1.04	1.05	1.03	1.04	1.05	50.0	4.86	3.77	3.13	4.92	3.81	3.15
100.0	1.03	1.04	1.05	1.03	1.04	1.05	1.03	1.04	1.05	1.03	1.04	1.05	100.0	4.83	3.76	3.13	4.89	3.80	3.15
200.0	1.04	1.05	1.06	1.04	1.05	1.05	1.03	1.04	1.05	1.03	1.04	1.05	200.0	4.80	3.75	3.13	4.88	3.78	3.15
300.0	1.03	1.05	1.06	1.04	1.05	1.06	1.04	1.05	1.05	1.03	1.05	1.05	300.0	4.79	3.73	3.11	4.91	3.78	3.13
400.0	1.04	1.05	1.06	1.04	1.05	1.06	1.04	1.05	1.06	1.04	1.05	1.06	400.0	4.79	3.72	3.09	4.89	3.76	3.11
500.0	1.05	1.06	1.06	1.05	1.06	1.07	1.04	1.06	1.07	1.04	1.05	1.06	500.0	4.79	3.70	3.06	4.87	3.74	3.11
600.0	1.05	1.06	1.07	1.04	1.06	1.08	1.05	1.06	1.08	1.04	1.06	1.08	600.0	4.78	3.68	3.05	4.87	3.73	3.08
700.0	1.06	1.07	1.08	1.06	1.07	1.08	1.06	1.07	1.08	1.05	1.07	1.08	700.0	4.74	3.67	3.04	4.87	3.70	3.05
800.0	1.06	1.07	1.09	1.06	1.07	1.08	1.06	1.08	1.09	1.06	1.07	1.08	800.0	4.73	3.65	3.02	4.83	3.69	3.04
900.0	1.06	1.07	1.09	1.06	1.08	1.09	1.07	1.09	1.11	1.06	1.08	1.09	900.0	4.73	3.62	2.98	4.83	3.68	3.03
1000.0	1.07	1.08	1.09	1.07	1.08	1.10	1.08	1.10	1.11	1.07	1.09	1.10	1000.0	4.72	3.60	2.96	4.84	3.66	3.00
1200.0	1.08	1.09	1.11	1.08	1.09	1.11	1.09	1.10	1.12	1.08	1.09	1.11	1200.0	4.67	3.58	2.95	4.79	3.64	2.98
1400.0	1.11	1.11	1.11	1.11	1.11	1.11	1.12	1.13	1.14	1.11	1.12	1.12	1400.0	4.64	3.53	2.87	4.78	3.59	2.92
1600.0	1.11	1.12	1.12	1.11	1.12	1.12	1.14	1.14	1.14	1.12	1.13	1.13	1600.0	4.59	3.49	2.84	4.74	3.55	2.89
1800.0	1.13	1.13	1.13	1.13	1.13	1.13	1.15	1.15	1.16	1.14	1.14	1.14	1800.0	4.54	3.44	2.80	4.67	3.50	2.85
2000.0	1.15	1.15	1.13	1.16	1.15	1.13	1.17	1.17	1.16	1.16	1.16	1.15	2000.0	4.50	3.40	2.77	4.64	3.45	2.80
2200.0	1.16	1.15	1.13	1.16	1.15	1.14	1.17	1.17	1.16	1.17	1.16	1.15	2200.0	4.41	3.34	2.73	4.53	3.39	2.76
2400.0	1.17	1.15	1.12	1.17	1.16	1.14	1.17	1.17	1.16	1.17	1.16	1.14	2400.0	4.37	3.27	2.68	4.47	3.35	2.73
2600.0	1.14	1.13	1.11	1.15	1.15	1.12	1.15	1.15	1.13	1.14	1.14	1.12	2600.0	4.28	3.25	2.69	4.46	3.31	2.72
2800.0	1.11	1.11	1.09	1.13	1.13	1.12	1.11	1.12	1.11	1.12	1.11	1.09	2800.0	4.30	3.21	2.66	4.37	3.29	2.71
3000.0	1.09	1.08	1.07	1.11	1.11	1.10	1.10	1.09	1.09	1.10	1.09	1.07	3000.0	4.25	3.24	2.69	4.38	3.27	2.71
3200.0	1.05	1.06	1.07	1.07	1.08	1.09	1.04	1.05	1.07	1.03	1.04	1.06	3200.0	4.29	3.25	2.72	4.41	3.29	2.72
3400.0	1.05	1.07	1.08	1.06	1.07	1.09	1.04	1.07	1.09	1.03	1.04	1.06	3400.0	4.35	3.29	2.77	4.42	3.32	2.75
3600.0	1.12	1.13	1.13	1.10	1.12	1.12	1.12	1.12	1.13	1.09	1.09	1.10	3600.0	4.47	3.39	2.84	4.59	3.40	2.82
3800.0	1.19	1.19	1.17	1.19	1.17	1.15	1.18	1.18	1.17	1.18	1.15	1.14	3800.0	4.63	3.52	2.95	4.77	3.52	2.90
4000.0	1.27	1.25	1.23	1.24	1.22	1.20	1.27	1.25	1.23	1.23	1.22	1.19	4000.0	4.89	3.69	3.09	4.89	3.63	3.00
4200.0	1.35	1.33	1.29	1.33	1.31	1.27	1.35	1.33	1.29	1.32	1.30	1.26	4200.0	5.13	3.86	3.21	5.19	3.81	3.12
4400.0	1.42	1.37	1.32	1.39	1.34	1.29	1.42	1.38	1.33	1.40	1.35	1.30	4400.0	5.34	4.06	3.32	5.44	3.98	3.25
4600.0	1.49	1.44	1.38	1.46	1.41	1.36	1.49	1.44	1.39	1.46	1.41	1.36	4600.0	5.68	4.27	3.48	5.70	4.16	3.41
4800.0	1.50	1.44	1.40	1.45	1.42	1.38	1.50	1.45	1.41	1.47	1.43	1.39	4800.0	5.95	4.41	3.61	6.03	4.37	3.53
5000.0	1.52	1.47	1.41	1.48	1.44	1.39	1.52	1.48	1.43	1.48	1.45	1.41	5000.0	6.32	4.61	3.73	6.24	4.52	3.68
5200.0	1.48	1.44	1.41	1.45	1.41	1.39	1.48	1.44	1.41	1.46	1.42	1.40	5200.0	6.46	4.69	3.81	6.49	4.63	3.73
5400.0	1.40	1.40	1.37	1.36	1.37	1.36	1.42	1.41	1.39	1.39	1.39	1.38	5400.0	6.68	4.78	3.85	6.63	4.75	3.80
5600.0	1.39	1.37	1.34	1.33	1.33	1.32	1.38	1.37	1.35	1.33	1.36	1.35	5600.0	6.81	4.86	3.91	6.66	4.83	3.90
5800.0	1.30	1.29	1.27	1.25	1.25	1.24	1.31	1.30	1.28	1.28	1.28	1.26	5800.0	6.81	4.80	3.87	6.86	4.79	3.79
6000.0	1.22	1.24	1.21	1.16	1.20	1.17	1.23	1.25	1.23	1.18	1.23	1.20	6000.0	6.83	4.79	3.83	6.61	4.77	3.76
6200.0	1.16	1.16	1.12	1.11	1.12	1.09	1.16	1.16	1.12	1.15	1.16	1.13	6200.0	6.66	4.69	3.73	6.66	4.70	3.69
6400.0	1.08	1.08	1.08	1.04	1.04	1.03	1.10	1.09	1.07	1.11	1.08	1.05	6400.0	6.39	4.62	3.59	6.53	4.56	3.53
6600.0	1.04	1.03	1.01	1.04	1.01	1.03	1.08	1.03	1.01	1.07	1.04	1.03	6600.0	6.01	4.45	3.50	6.15	4.43	3.49
6800.0	1.05	1.08	1.08	1.05	1.11	1.13	1.08	1.08	1.09	1.07	1.08	1.09	6800.0	5.85	4.30	3.36	6.19	4.26	3.29
7000.0	1.13	1.14	1.14	1.14	1.17	1.18	1.16	1.15	1.15	1.11	1.14	1.15	7000.0	5.77	4.15	3.29	6.03	4.13	3.23
7200.0	1.19	1.22	1.24	1.20	1.25	1.25	1.20	1.23	1.23	1.18	1.21	1.19	7200.0	5.44	3.97	3.15	5.66	4.01	3.20
7400.0	1.23	1.28	1.27	1.25	1.33	1.32	1.24	1.29	1.26	1.22	1.27	1.27	7400.0	5.38	3.86	3.11	5.61	3.84	3.03
7600.0	1.32	1.31	1.31	1.32	1.34	1.34	1.32	1.32	1.30	1.26	1.29	1.29	7600.0	5.09	3.76	3.07	5.44	3.75	3.01
7800.0	1.35	1.39	1.38	1.40	1.42	1.41	1.34	1.38	1.36	1.36	1.34	1.33	7800.0	5.10	3.64	2.94	5.02	3.70	2.96
8000.0	1.41	1.36	1.32	1.44	1.40	1.35	1.41	1.37	1.32	1.37	1.34	1.31	8000.0	4.82	3.64	3.00	5.04	3.59	2.88

*Note:

State of:		RF Common to	
Control Voltage	Enable	RF1	RF2
HIGH	HIGH	ON	OFF
LOW	HIGH	OFF	ON
LOW/HIGH	LOW	Shutdown	

ON - Low insertion loss state
 OFF - Isolation state



P.O. Box 350166, Brooklyn, New York 11235-0003 (718) 934-4500 • Fax (718) 332-4661 For detailed performance specs & shopping online see Mini-Circuits web site
 The Design Engineers Search Engine Provides ACTUAL Data Instantly From MINI-CIRCUITS At: www.minicircuits.com



IF/RF MICROWAVE COMPONENTS

Typical Performance Curves

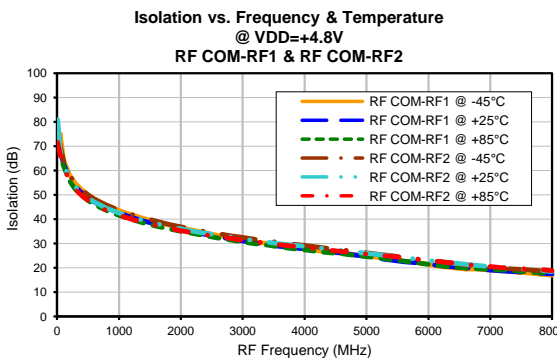
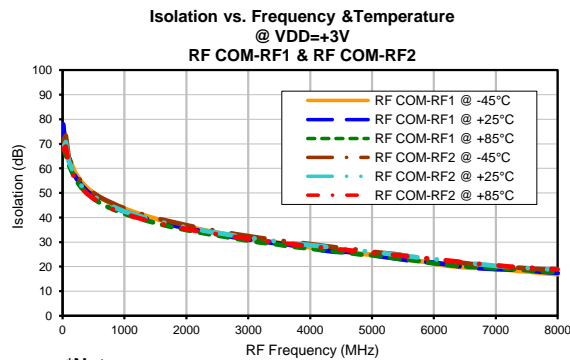
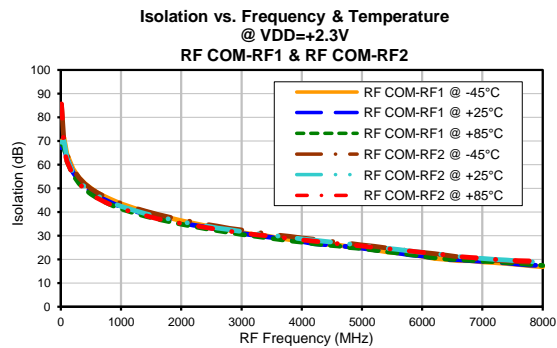
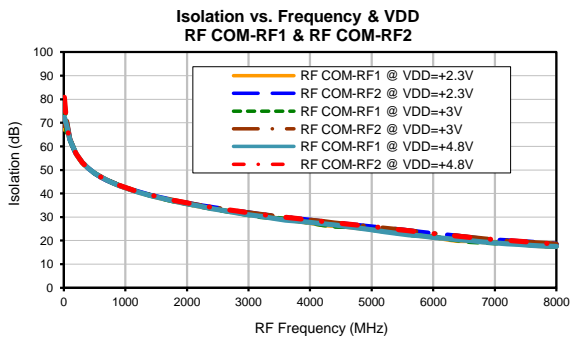
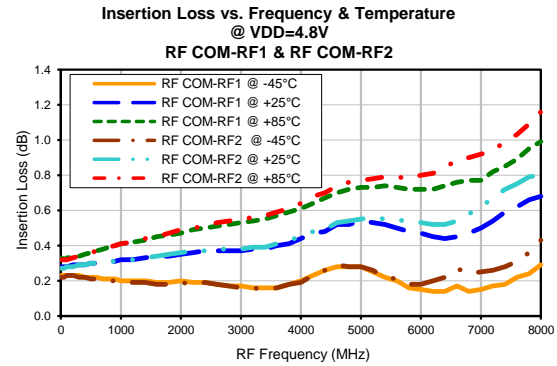
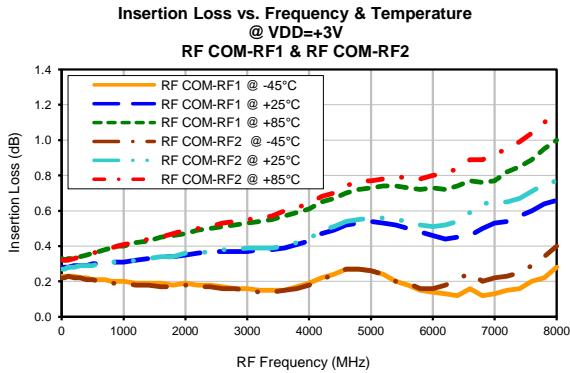
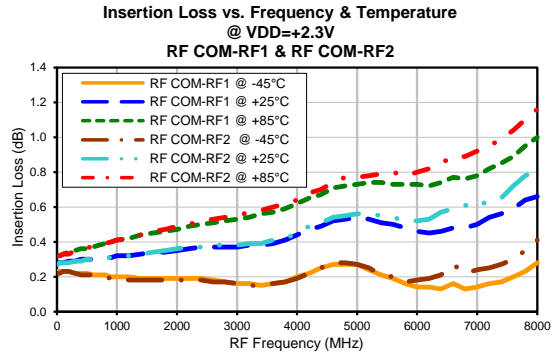
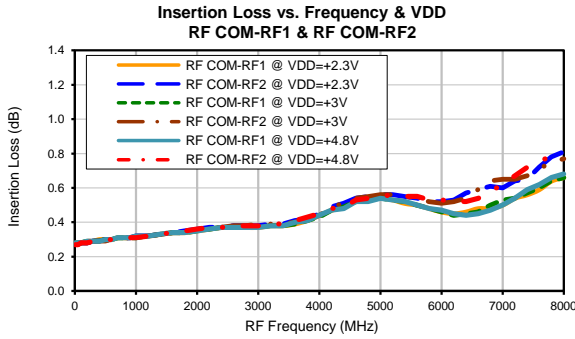

*Note:

Control Voltage	State of:		RF Common to	
	Enable		RF1	RF2
HIGH	HIGH		ON	OFF
LOW	HIGH		OFF	ON
LOW/HIGH	LOW		Shutdown	

ON - Low insertion loss state
 OFF - Isolation state

Typical Performance Curves

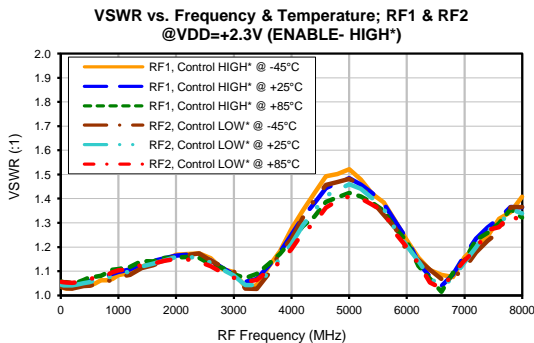
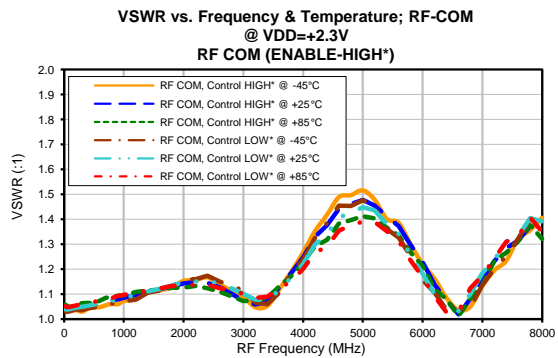
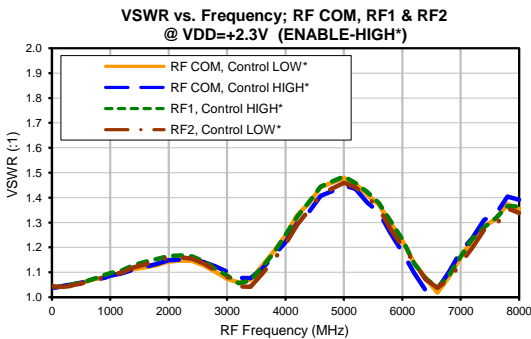
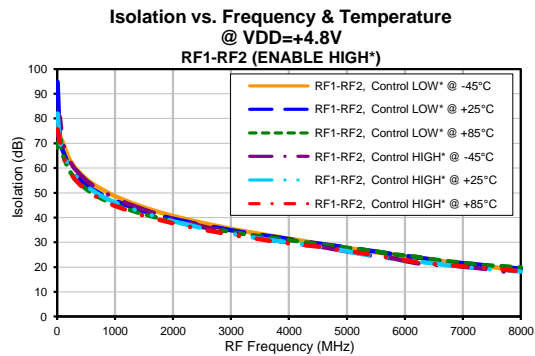
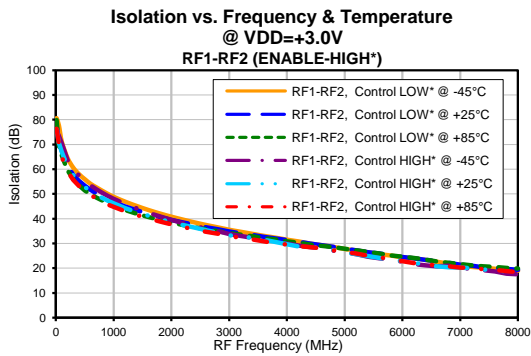
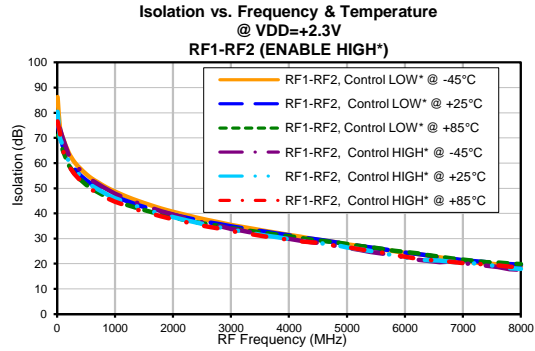
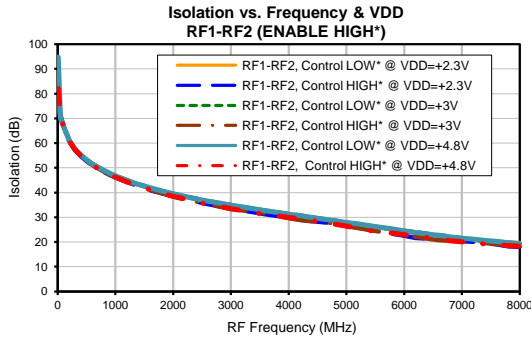

*Note:

Control Voltage	State of:		RF Common to	
	Enable		RF1	RF2
HIGH	HIGH	ON	OFF	
LOW	HIGH	OFF	ON	
LOW/HIGH	LOW	Shutdown		
ON - Low insertion loss state				
OFF - Isolation state				

Typical Performance Curves

VSWR vs. Frequency; RF COM, RF1 & RF2 @ VDD=+3V (ENABLE-HIGH*)

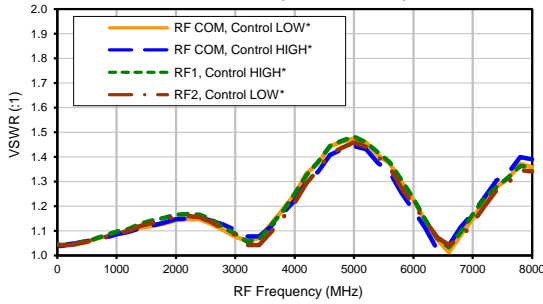

VSWR vs. Frequency & Temperature; RF COM @ VDD=+3V (ENABLE-HIGH*)

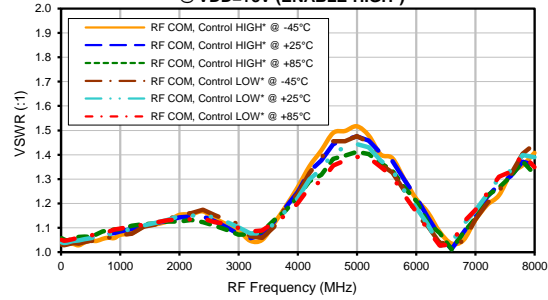

VSWR vs. Frequency & Temperature; RF1 & RF2 @ VDD=+3V (ENABLE-HIGH*)

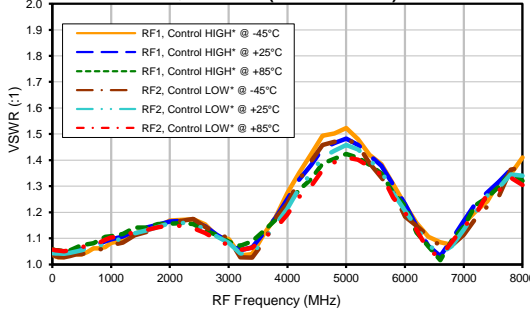

VSWR vs. Frequency; RF COM, RF1 & RF2 @ VDD=+4.8V (ENABLE-HIGH*)

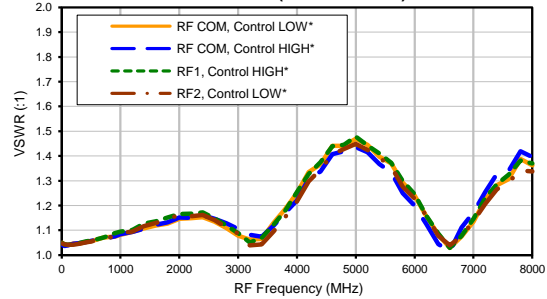

VSWR vs. Frequency & Temperature; RF COM @ VDD=+4.8V (ENABLE-HIGH*)

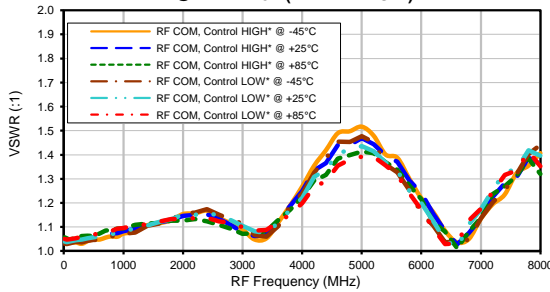

VSWR vs. Frequency & Temperature; RF1 & RF2 @ VDD=+4.8V (ENABLE-HIGH*)

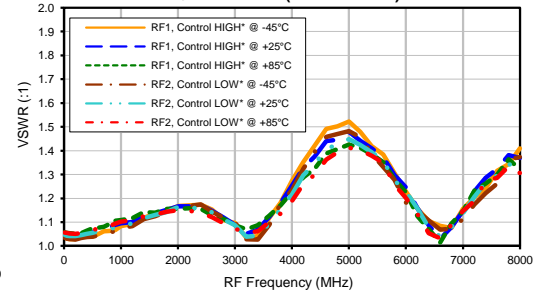

VSWR vs. FREQUENCY & VDD; RF1 & RF2 (OFF) (ENABLE-HIGH*)

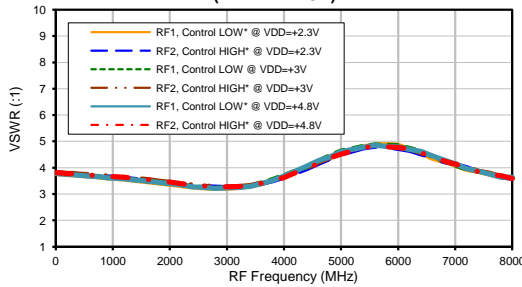

VSWR vs. Frequency & Temperature; RF1 & RF2 (OFF) @ VDD=+2.3V (ENABLE-HIGH*)

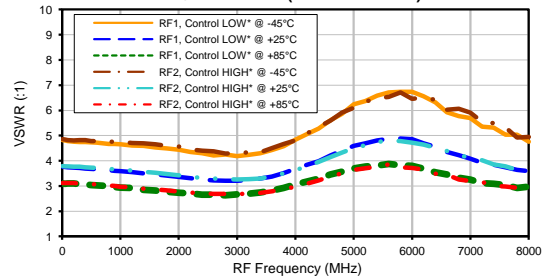

*Note:

State of:		RF Common to	
HIGH	Enable	RF1	RF2
HIGH	HIGH	ON	OFF
LOW	HIGH	OFF	ON
LOW/HIGH	LOW	Shutdown	

ON - Low insertion loss state
OFF - Isolation state

Typical Performance Curves

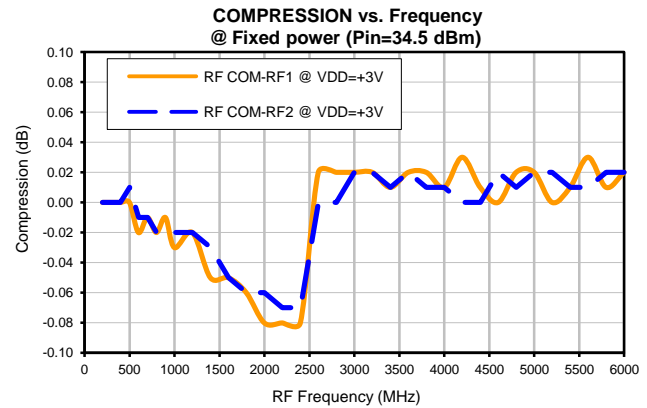
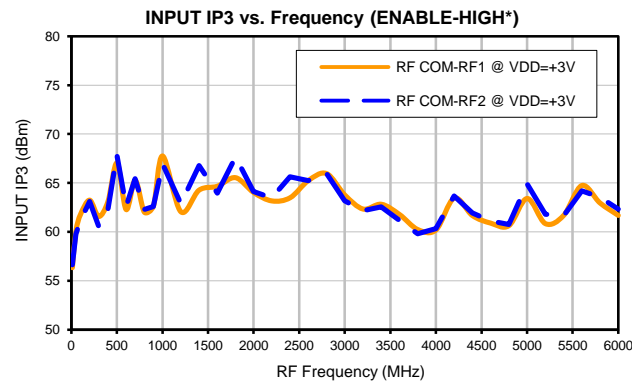
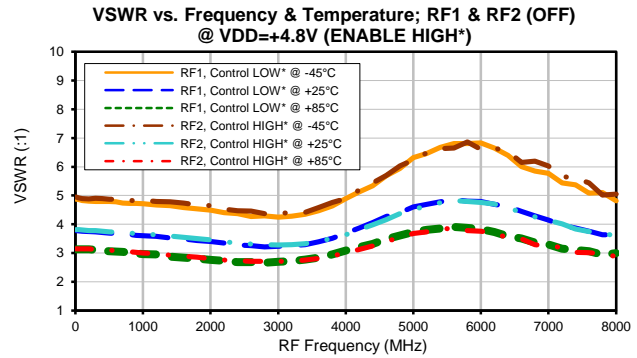
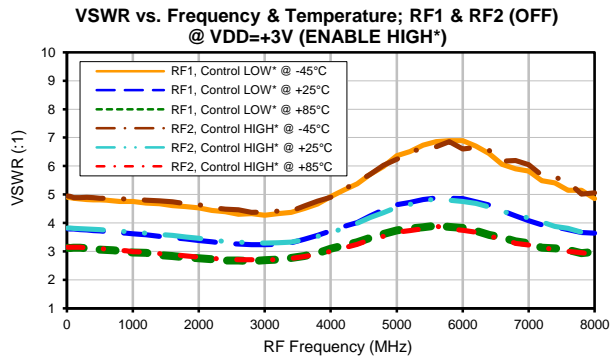

*Note:

State of:		RF Common to	
Control Voltage	Enable	RF1	RF2
HIGH	HIGH	ON	OFF
LOW	HIGH	OFF	ON
LOW/HIGH	LOW	Shutdown	

ON - Low insertion loss state
OFF - Isolation state

Outline Dimensions

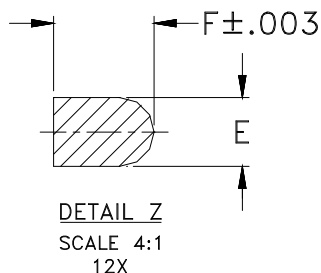
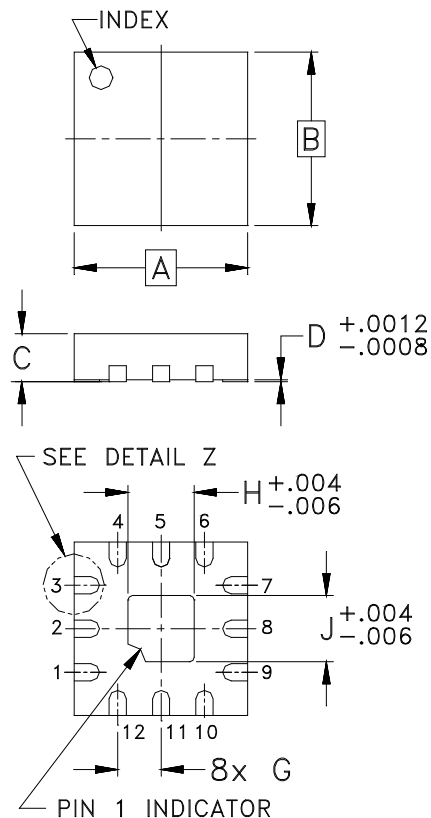

PCB Land Pattern

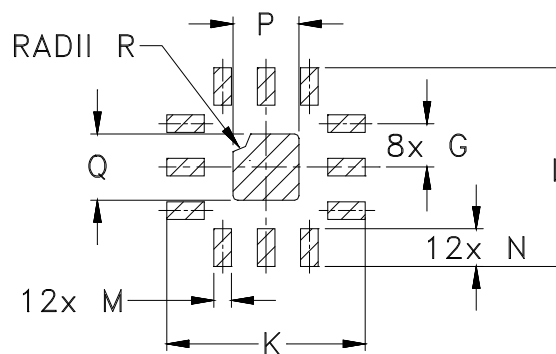

Suggested Layout,
Tolerance to be within $\pm .002$

CASE#	A	B	C	D	E	F	G	H	J	K	L	M	N
MT1818	.079 (2.00)	.079 (2.00)	.022 (0.55)	.0008 (0.02)	.008 (0.20)	.011 (0.29)	.020 (0.50)	.030 (0.76)	.030 (0.76)	.090 (2.29)	.090 (2.29)	.008 (0.20)	.018 (0.44)

CASE#	P	Q	R	WT, GRAM
MT1818	.030 (0.76)	.030 (0.76)	.008 (0.20)	.010

Dimensions are in inches (mm). Tolerances: 3 Pl. $\pm .002$

Notes:

1. Case material: Plastic.
2. Termination finish: Ni Pd Au.

Tape & Reel Packaging TR-F108

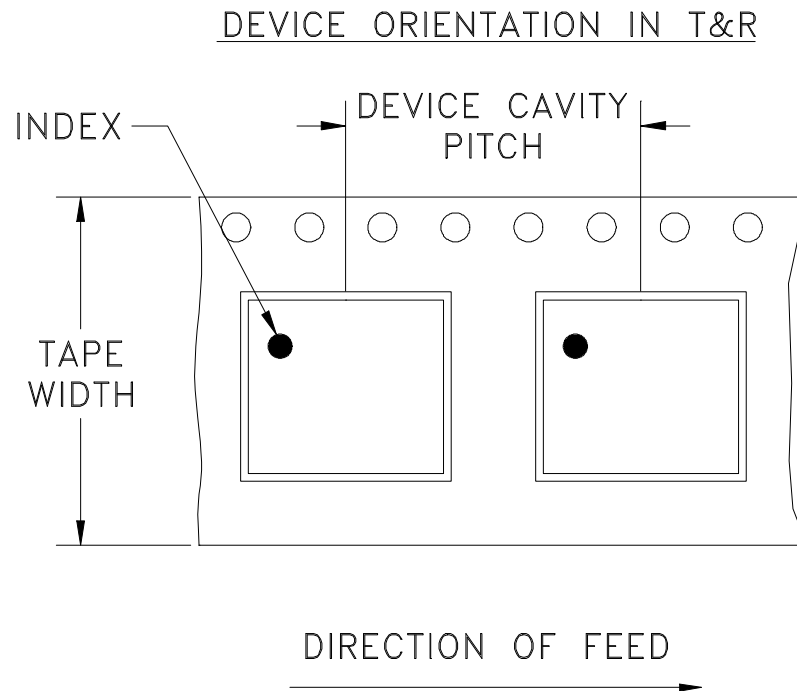

Tape Width, mm	Device Cavity Pitch, mm	Reel Size, inches	Devices per Reel	
12	4	7	Small quantity standards	20
				50
				100
				200
				500
				1000
		7	Standard	2000
				3000

Note: Please Consult individual data sheet to determine device per reel availability

Mini-Circuits carrier tape materials provide protection from ESD (Electro-Static Discharge) during handling and transportation. Tapes are static dissipative and comply with industry standards EIA-481/EIA-541.

Go to: www.minicircuits.com/pages/pdfs/tape.pdf



INTERNET <http://www.minicircuits.com>

P.O. Box 350166, Brooklyn, New York 11235-0003 (718) 934-4500 Fax (718) 332-4661

Distribution Centers NORTH AMERICA 800-654-7949 • 417-335-5935 • Fax 417-335-5945 • EUROPE 44-1252-832600 • Fax 44-1252-837010

Mini-Circuits ISO 9001 & ISO 14001 Certified

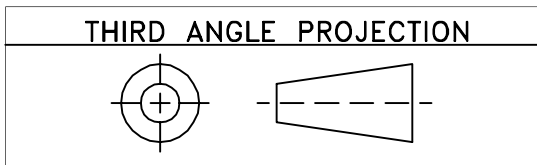

REVISIONS					
REV	ECN No.	DESCRIPTION	DATE	DR	AUTH
OR	M145642	NEW RELEASE	03/11/14	AV	RS

**SUGGESTED MOUNTING CONFIGURATION
FOR MT1818 CASE STYLE, "12SW01" PIN CODE**

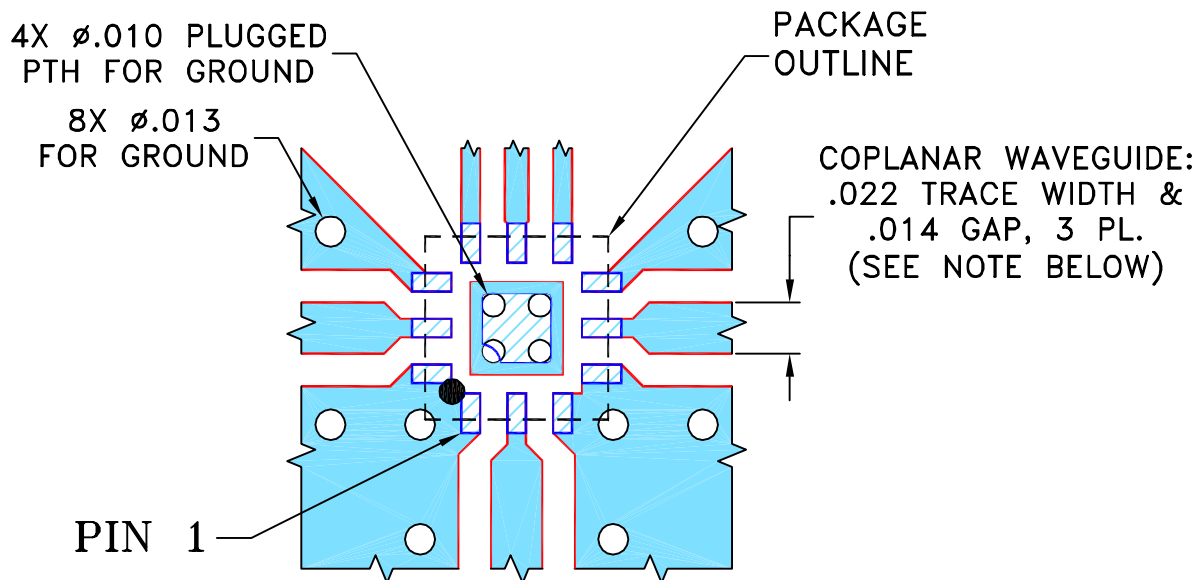

NOTES:

1. TRACE WIDTH IS SHOWN FOR ROGERS RO4350B WITH DIELECTRIC THICKNESS .010" ± .001". COPPER: 1/2 OZ. EACH SIDE. FOR OTHER MATERIALS TRACE WIDTH AND GAP MAY NEED TO BE MODIFIED.
2. BOTTOM SIDE OF THE PCB IS CONTINUOUS GROUND PLANE.

 DENOTES PCB COPPER LAYOUT WITH SMOBC (SOLDER MASK OVER BARE COPPER).

 DENOTES COPPER LAND PATTERN FREE OF SOLDER MASK.

UNLESS OTHERWISE SPECIFIED	INITIALS	DATE
DIMENSIONS ARE IN INCHES	DRAWN AV	03/11/14
TOLERANCES ON:	CHECKED IL	03/11/14
2 PL DECIMALS ±	APPROVED RS	03/11/14
3 PL DECIMALS ± .005		
ANGLES ±		
FRACTIONS ±		

 **Mini-Circuits®** 13 Neptune Avenue
Brooklyn NY 11235

PL, 12SW01, MT1818, TB-725+

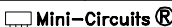
 Mini-Circuits®
THIS DOCUMENT AND ITS CONTENTS ARE THE PROPERTY OF MINI-CIRCUITS. EXCEPT FOR USE EXPRESSLY GRANTED, IN WRITING, TO ITS VENDORS, VENDEE AND THE UNITED STATES GOVERNMENT, MINI-CIRCUITS RESERVES ALL PROPRIETARY DESIGN, USE, MANUFACTURING AND REPRODUCTION RIGHTS THERETO. THESE CONTENTS SHALL NOT BE USED, DUPLICATED OR DISCLOSED TO ANY OUTSIDE PARTY, IN WHOLE OR IN PART, WITHOUT WRITTEN PERMISSION OF MINI-CIRCUITS.

ASHEETA1.DWG REV:A DATE:01/12/95

SIZE	CODE IDENT	DRAWING NO:	REV:
A	15542	98-PL-414	OR
FILE:	98PL414	SCALE: 12:1	SHEET: 1 OF 1

Evaluation Board and Circuit

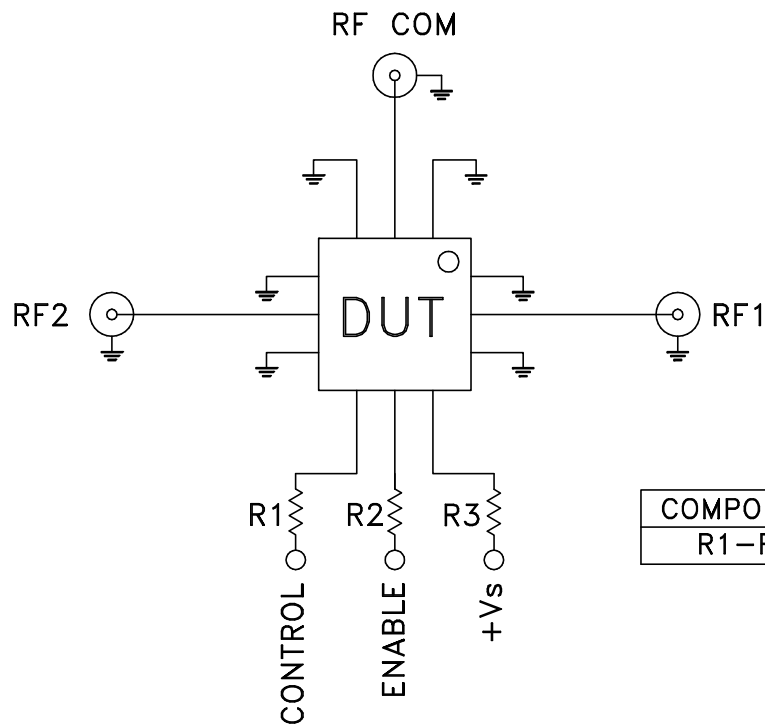
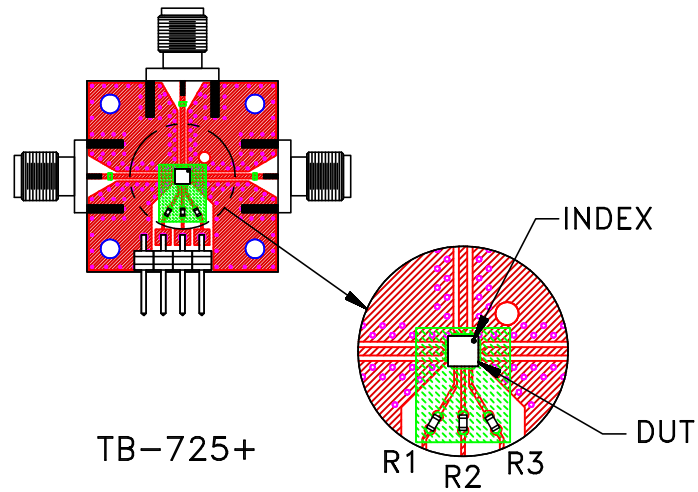

COMPONENT	VALUE	SIZE
R1-R3	1 kOhm	0402

Schematic Diagram

Notes:

1. 50 Ohm SMA Female connectors.
2. PCB Material: R04350 or equivalent,
Dielectric Constant=3.5, Thickness=.030 inch.

 Mini-Circuits®

All Mini-Circuits products are manufactured under exacting quality assurance and control standards, and are capable of meeting published specifications after being subjected to any or all of the following physical and environmental test.

Specification	Test/Inspection Condition	Reference/Spec
Operating Temperature	-40° to 85° C Ambient Environment	Individual Model Data Sheet
Storage Temperature	-65° to 150° C / -40° to 125° C / -55° to 150° C Ambient Environment	Individual Model Data Sheet
Temperature Cycling	-65° to 150°C, 500 cycles	JESD22-A104, condition C
HAST	130°C, 85% RH, 33 PSIA, 96 hours, nominal bias	JESD22-A110
High Temp Storage	150°C 1000 hours	JESD22-A103
Solderability	Per Reference Spec	JESD22-B102
Moisture Sensitivity: Level 1	Bake at 125°C for 24 hours Soak at 85°C/85% RH for 168 hours, Reflow 3 cycles at 260°C peak	J-STD-020 D.01